

Operation manual

Versafreeze freezer cabinets

VF 15040, VF 60040, VF 70040, VF 15085, VF 60085, VF 70085



Manufacturer:

LAUDA DR. R. WOBSEY GMBH & CO. KG

Schulze-Delitzsch-Straße 4+5

30938 Burgwedel

Germany

Telephone: +49 (0)5139 9958-0

E-mail: info@lauda.de

Internet: <https://www.lauda.de>

Translation of the original operation manual

Q4DT-E_13-016_V3, 1, en_US 07/01/2024 © LAUDA 2024

Table of contents

1	Safety.....	7
1.1	Safety structure of the device.....	7
1.2	Obligations of the operator.....	8
1.3	EMC requirements.....	8
1.4	Software versions.....	8
1.5	Intended use.....	8
1.6	Unintended use.....	9
1.7	Foreseeable misuse.....	9
1.8	Type of power supply.....	9
1.9	Prohibition of modifications to the device.....	9
1.10	Ambient conditions and operating conditions.....	9
1.11	Materials.....	10
1.12	Time limits.....	10
1.13	Natural refrigerant.....	10
1.14	Application area.....	10
1.15	Description of personnel qualifications.....	10
1.16	Description of personal protective equipment.....	11
1.17	Safety fittings on the device.....	12
1.17.1	Alarm messages and potential-free contact.....	12
1.17.2	Sensor monitoring.....	12
1.17.3	Mains power failure.....	12
1.17.4	Internal data logger battery alarm.....	13
1.17.5	Overtemperature alarm.....	13
1.17.6	Low temperature alarm.....	13
1.18	Warning symbols on the device.....	13
1.19	Residual risks.....	13
1.20	Structure of warnings.....	14
2	Unpacking the device.....	15
2.1	Safety information.....	15
2.2	Unpacking.....	15
2.3	Operating manual catalog number.....	16
3	Transport.....	17
3.1	Transporting the deep-freezer.....	17
3.2	Transport with an industrial truck.....	18
4	Structure and function.....	19
4.1	Device function description.....	19
4.2	Structure of freezer cabinets.....	19

4.3	Undercounter installation applicable for VF 15040 and VF 15085.....	24
4.4	Touch operating unit.....	25
4.5	Operating elements.....	29
4.5.1	Mains switch.....	29
4.5.2	Refrigeration compartment lock.....	29
4.6	Rating label.....	30
4.7	Internal data logger.....	30
4.8	Limit values USr user level, factory setting.....	31
5	Before starting up.....	32
5.1	Installation.....	32
5.2	Selecting the menu language.....	33
5.3	Setting the date and time.....	34
5.4	Setting the temperature unit.....	35
5.5	Changing the record interval for the internal data logger.....	36
5.6	Changing the plant name.....	37
5.7	Displaying software information.....	38
5.8	Displaying copyright information.....	39
6	Commissioning.....	41
6.1	Establishing a mains connection.....	41
6.2	Switching the device on and off.....	43
6.3	Defining user profiles.....	44
6.4	Selecting a user profile.....	45
6.5	Changing the user profile password.....	45
6.6	Creating a new user name.....	47
6.7	Configuring user profile rights.....	48
6.8	Activating auto logout.....	49
6.9	Selecting and displaying control curves.....	51
6.10	Setting alarm limit values.....	51
6.10.1	Setting the alarm delay limit value for the device lid.....	51
6.10.2	Setting a limit value for the low temperature alarm.....	53
6.10.3	Setting a limit value for the overtemperature alarm.....	55
7	Operation.....	57
7.1	Safety information.....	57
7.1.1	General safety instructions.....	57
7.2	Adjustment of the cooling chamber temperature set point.....	58
7.3	Storing and retrieving refrigerated goods.....	59
7.4	Alarm management.....	59
7.5	Data transfer via USB.....	61
7.6	Setting up an Internet connection for forwarding alarms.....	62

7.6.1	Setting up email addresses.....	63
7.6.2	Setting up an email server configuration.....	64
7.7	Resetting an alarm.....	65
7.8	Internal data logger and history function.....	65
7.9	Variant: Operating the device with CO ₂ /LN ₂ safety cooling.....	66
7.10	Variant: Water cooling.....	68
8	Maintenance.....	70
8.1	General safety instructions.....	70
8.2	Maintenance plan.....	71
8.3	Cleaning the device.....	71
8.4	Cleaning the condenser fins.....	72
8.5	Defrosting the refrigeration compartment.....	73
8.6	Flushing the cooling water system on the water-cooled variant:.....	73
9	Faults.....	76
9.1	Alarms, warnings and errors.....	76
10	Decommissioning.....	79
10.1	General information on decommissioning.....	79
11	Disposal.....	80
11.1	Disposing of refrigerant.....	80
11.2	Device disposal.....	80
11.3	Disposing of packaging.....	80
12	Technical data.....	81
12.1	Touch operating unit data.....	81
12.2	Auxiliary battery data.....	81
12.3	Device data.....	81
12.4	Refrigerant and filling charge.....	84
12.5	Circuit diagram.....	85
12.5.1	Legend for the following circuit diagrams.....	85
12.5.2	Circuit diagram: VF 15040, 115V/60Hz.....	86
12.5.3	Circuit diagram: VF 15040, 230V/50Hz.....	87
12.5.4	Circuit diagram: VF 15085, 115V/60Hz.....	88
12.5.5	Circuit diagram: VF 15085, 230V/50Hz.....	89
12.5.6	Circuit diagram: VF 60040 and VF 70040, 115V/60Hz.....	90
12.5.7	Circuit diagram: VF 60040 and VF 70040, 230V/50Hz.....	91
12.5.8	Circuit diagram: VF 60085 and VF 70085, 115V/60Hz.....	92
12.5.9	Circuit diagram: VF 60085 and VF 70085, 230V/50Hz.....	93
12.5.10	Touch operating unit.....	94
12.5.11	Single-board refrigeration controller A1.....	95
13	Auxiliary devices.....	96

13.1	Auxiliary devices for data loggers and storage systems.....	96
13.1.1	Data logger for monitoring and recording the temperature in the refrigeration compartment.....	96
13.1.2	Storage system.....	97
14	General.....	99
14.1	Copyright.....	99
14.2	Technical changes.....	99
14.3	Warranty conditions.....	99
14.4	Contact LAUDA.....	99
14.5	Declaration of Conformity.....	100
14.6	Certificate.....	101
14.7	Product Returns and Clearance Declaration.....	103
15	Index.....	104

1 Safety

1.1 Safety structure of the device

IMPORTANT:

- Always read the operating manual carefully before operating the device.
- This operating manual is part of the device. If the device is passed on, the operating manual must be handed over with it.
- The information in this operating manual must therefore be kept at hand in the immediate vicinity of the device.
- Be sure to carefully store this copy of the operating manual.
- The operating manual is available on our website (<https://www.lauda.de>).
- The device must only be operated as intended under the conditions stated in this operating manual. Any other mode of operation is considered to be unintended use and could compromise the protection provided by the device.
- The device is not designed for use in medical applications in accordance with DIN EN 60601-1 and IEC 601-1.



If this operating manual is lost, contact LAUDA Service. You can find the contact information here ↪ Chapter 14.4 "Contact LAUDA" on page 99.

When operating the device, there is a risk of injury from low temperatures, fire and the presence of electrical energy. These risks posed by the device have been mitigated in the design to the extent possible in keeping with the applicable norms. The remaining risk can be reduced using one of the following measures:

- Safety equipment is available for the device. This equipment is crucial for device safety and must be controlled by the user. All maintenance intervals must be observed and appropriate maintenance activities must be performed to ensure the functionality of the equipment.
- The safety equipment for the device is described in this "Safety" chapter.
- Various warning symbols are located on the device. These symbols must be observed without fail.
- The warning symbols on the device are described in this "Safety" chapter.
- This operating manual contains safety information. This information must be followed at all times.
- Personnel and the protective equipment worn by personnel are also subject to specific requirements.
- These requirements are described in this "Safety" chapter.
- The device may only be operated by trained personnel.
- Never put the device into operation if:
 - it is damaged,
 - it is leaking (for example, refrigerant is escaping),
 - the mains cable and/or other cables are damaged.
- Switch off the device and pull out the mains plug, see ↪ Chapter 6.2 "Switching the device on and off" on page 43:
 - before starting service work or repair work
 - when transporting the device
 - when installing or removing accessory parts



An overview of authorized personnel and protective equipment can be found in ↪ Chapter 1.15 “Description of personnel qualifications” on page 10 and ↪ Chapter 1.16 “Description of personal protective equipment” on page 11.



Refer to ↪ Chapter 1.20 “Structure of warnings” on page 14 for more information on the general structure of safety notices.

1.2 Obligations of the operator

The national regulations for operation applicable in the country in which the system is installed must be complied with.

In particular, the application of statutory regulations concerning operational safety must be observed.

The conditions for setting up the device must always be met. See also the information in the device specifications ↪ Chapter 12.3 “Device data” on page 81.

The device may only be used, maintained and repaired in accordance with the manufacturer’s instructions. It must not be modified or fitted with attachments without ensuring that the device is still safe. The safety of the device must be guaranteed at all times.

1.3 EMC requirements

Table 1: Classification in accordance with EMC requirements

Device	Immunity requirements	Emissions class	Customer power supply
Versafreeze low temperature chest freezer/low temperature refrigerator	Table 2 (industry) according to EN 61326-1	Emissions class B according to EN 55016-2	within the EU Domestic connection value ≥ 100 A

1.4 Software versions

This operating manual is valid for devices with the following software versions or higher.

Software	Valid from version
Single-board refrigeration controller	1.29
Operating unit	HMI 2.3.861

1.5 Intended use

- The LAUDA Versafreeze is a freezer cabinet designed for industrial applications.
- Freezer cabinet models VF 15040, VF 60040 and VF 70040 can operate at temperatures as low as -40 °C.
Freezer cabinet models VF 15085, VF 60085 and VF 70085 can operate at temperatures between -50 °C and -86 °C.

- The device is designed exclusively for storing and controlling the temperature of non-hazardous substances such as chemicals, pharmaceutical substances and medicines.
- The device may only be operated with the integrated mains plug.
- The freezer cabinet is loaded and unloaded from the front. The device door must be opened prior to loading or unloading.

1.6 Unintended use

The following are considered examples of unintended use:

- Storage of highly flammable/self-igniting and/or explosive substances, acids and alkalis that are chemically unstable and/or release gases
- Medical applications (the device does not have medical device approval)
- Installation and operation in hazardous areas and outside the permitted ambient conditions
- Use for controlling the temperature of foodstuffs
- Use in aggressive or corrosive ambient conditions
- Storage of substances that attack the materials incorporated into the device, such as stainless steel, elastomers and sensors.
- Outdoor installation
- Storage of hazardous substances that emit harmful fumes
- Installation and operation in the vicinity of naked flames
- The presence or storage of animals or people in the refrigeration compartment

1.7 Foreseeable misuse

The following are considered cases of foreseeable misuse:

- Medical applications

1.8 Type of power supply

- Electrical energy
 - for operating the device

1.9 Prohibition of modifications to the device

Any technical modification of the device by the user is prohibited. Any damage resulting from unauthorized modification is not covered by customer service or the product warranty. Service work may only be performed by the LAUDA Service department or a service partner authorized by LAUDA.

Only original spare parts may be used.

1.10 Ambient conditions and operating conditions

Observe the following requirements when setting up the device:

- The installation site must be level and horizontal and suitable for supporting the weight of the device.
- Only used inside buildings
- Use up to a maximum height of 2,000 m above sea level
- Maximum relative humidity 80 percent, non-condensing

- Fluctuations of the mains voltage up to ± 10 of the nominal voltage
- Overvoltage category II
- Pollution degree 2
- Positioned at a minimum distance of 150 mm away from walls or other devices so that the air drawn in for cooling can circulate freely.
- The condenser must not be covered or obstructed as air circulation must be guaranteed.
- In order to prevent an increase in the compartment temperature resulting from a reduction in cooling capacity, the ambient temperature (16-28°C) must not exceed 28°C.
- In smaller installation rooms, please ensure that the heat discharged from the device's active cooling system does not cause the ambient temperature (see technical data) to exceed the maximum limit.
- Ensure that the installation room has adequate ventilation and cooling.

1.11 Materials

All parts of the device are manufactured from high-quality materials adapted to withstand the operating temperature. The range of materials used includes high-quality stainless steels and high-quality, temperature-resistant plastics. The compartment is manufactured entirely from stainless steel.

1.12 Time limits

- The device is designed to operate continuously for 20,000 hours.
- Refer to the maintenance plan for information on maintenance intervals.

1.13 Natural refrigerant

The device operates using odorless, natural refrigerant. These refrigerants are flammable. There are no special installation requirements due to the low refrigerant charge and hermetically sealed design. The designation and refrigerant charge are specified on the type plate, see ↗ Further information on page 30, ↗ Chapter 5.1 "Installation" on page 32, and ↗ Chapter 12.4 "Refrigerant and filling charge" on page 84.

1.14 Application area

The device may only be used in the following areas.

- Logistics, production, quality assurance, research and development in an industrial environment
- Indoors

1.15 Description of personnel qualifications

Forklift driver

The forklift driver must be 18 years old or over and have physical, mental and character-related qualities that are suitable for driving industrial trucks that have a driver's seat or driver's cab.

Furthermore, the forklift driver has been trained to drive industrial trucks that have a driver's seat or driver's cab.

The forklift driver has demonstrated to the operator his or her ability to drive industrial trucks that have a driver's seat or driver's cab, and the operator then commissions the driver in writing to drive the vehicles.

Instructed person

The operator has informed the instructed person about the tasks assigned to them and the possible risks of improper behavior.

Refrigeration specialist

Refrigeration specialists are specially trained and certified for the specialist field in which they are active and know all the applicable standards and regulations. The certification includes the expertise required to avoid emissions, recover fluorinated greenhouse gases and safely handle refrigeration equipment of the relevant type and size.

Refrigeration specialists are able to carry out work on refrigeration systems and independently recognize and avoid possible dangers based on their professional training and experience.

A certificate relating to (EU) No. 2024/573 and (EU) No. 2015/2067 must be available.

Specialized personnel

Specialized personnel are able to perform the work assigned to them as well as identify and avoid potential dangers independently based on their professional training, knowledge and experience as well as knowledge of the relevant provisions.

1.16 Description of personal protective equipment



Cold protection gloves

Cold protection gloves are leather safety gloves that are resistant to acid and cold.

Safety gloves are used to protect the hands when touching refrigerated components and small quantities of refrigerants.



Protective gloves

Protective gloves are worn to prevent injuries when removing external protective panels.



Protective work clothing

Protective work clothing is tight-fitting work clothing with a low tear resistance, tight sleeves and no protruding parts. It is primarily used to protect personnel from becoming caught in moving machine parts. Do not wear rings, necklaces or other jewelry.



Safety glasses

Safety glasses are used to protect the eyes from flying parts and liquid splashes.



Safety shoes

Safety shoes are worn to provide protection against heavy falling objects and prevent slipping on slippery surfaces. They also protect the feet when removing exterior protective panels.

1.17 Safety fittings on the device

1.17.1 Alarm messages and potential-free contact

In the event of a malfunction, an alarm is triggered.

Each alarm is indicated acoustically in the form of an alarm signal (1 second on – 1 second off) and visually on the Touch operating unit display.

All alarms that occur are saved in the internal data logger.

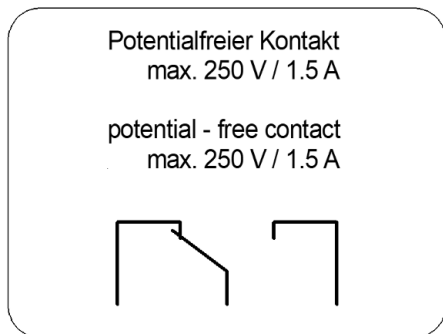

When the acoustic alarm signal is issued, the potential-free alarm contact is activated for connection to the fault monitoring system belonging to the company.

The connection is located in the device's control cabinet and marked with a sticker.

The maximum load capacity of the contact is 250 V / 1.5 A.

Fig. 1: Potential-free contact

1.17.2 Sensor monitoring

The controller's temperature probe is continuously checked for short circuits and interruptions.

If a malfunction occurs, an alarm message is issued, see [Chapter 1.17.1 "Alarm messages and potential-free contact"](#) on page 12

If the sensor develops a fault, the emergency program starts. The device cools alternately for 30 minutes with the compressor running, and then stops for 10 minutes.

Note:

- During the emergency program, the temperature may vary from the set temperature in the compartment.

1.17.3 Mains power failure

In the event of a mains power failure, an acoustic warning signal sounds (1 second on – 1 second off) and the potential-free alarm contact is activated. The [power failure] fault message remains on the Touch operating unit display until it is acknowledged.

In the event of a complete power failure, the battery of the internal data logger will keep the Touch operating unit display and data recording (internal data logger) operational for approximately 35 hours.

1.17.4 Internal data logger battery alarm

If the battery in the internal data logger develops a fault, a corresponding message and the current temperature appear alternately in text form on the display.

An acoustic alarm sounds (1 second on – 1 second off).

The potential-free alarm contact is activated.

Always observe the legal regulations when disposing of a faulty battery from the internal data logger.

1.17.5 Overtemperature alarm

The overtemperature protection is a warning device that is activated when the temperature in the refrigeration compartment exceeds the specified upper limit.

This information is shown on the Touch operating unit display.

An acoustic alarm sounds (1 second on – 1 second off).

The potential-free contact is activated.

1.17.6 Low temperature alarm

The low temperature protection is a warning device that is activated when the temperature in the refrigeration compartment falls below the specified lower limit.

This information is shown on the Touch operating unit display.

An acoustic alarm sounds (1 second on – 1 second off).

The potential-free contact is activated.

1.18 Warning symbols on the device

Cold surfaces



"Cold surface" warning symbols are affixed to the device. This symbol warns of cold surfaces on the device. These surfaces must not be touched during operation. Personal protective equipment must be worn before coming into contact with these surfaces during other operation phases such as servicing.

Flammable



- The "Flammable" warning symbol is attached to devices filled with natural refrigerants.

This symbol warns of the flammability of natural refrigerant.

1.19 Residual risks

The safety instructions/warning information in the operating instructions describe any residual risks on the device.

1.20 Structure of warnings

Dangerous

- A warning of "dangerous" indicates an **immediately dangerous** situation.
- If this warning is not observed, then **death** or **severe, irreversible injury** could occur.

 DANGER! Type and source	
	Consequences of not following instructions
	<ul style="list-style-type: none">● Measure 1● Measure...

Warning

- A warning of "warning" indicates a **possibly dangerous** situation.
- If this warning is not observed, then **death** or **severe, irreversible injury** could occur.

 WARNING! Type and source	
	Consequences of not following instructions
	<ul style="list-style-type: none">● Measure 1● Measure...

Caution

- A warning of "caution" indicates a **possibly dangerous** situation.
- If this warning is not observed, then **minor, reversible injury** could occur.

 CAUTION! Type and source	
	Consequences of not following instructions
	<ul style="list-style-type: none">● Measure 1● Measure...

Notice

A "notice" warns that dangers to property or the environment may exist.

 NOTICE! Type and source	
	Consequences of not following instructions
	<ul style="list-style-type: none">● Measure 1● Measure...

2 Unpacking the device

2.1 Safety information



WARNING!
Leaks in the cooling circuit due to transport damage

Fire

If you discover that the transport packaging is damaged:

- Place/store the device in a well-ventilated location with no sources of ignition.
- Do not operate the device.
- Contact LAUDA Service.



CAUTION!
Transport damage

Cutting

- Closely inspect the device for transport damage prior to starting up.
- Never operate a device that has sustained transport damage.



NOTICE!
Aids/lifting equipment used during unpacking

Impact, crushing, material damage

- Use suitable aids when unpacking.
- Use suitable lifting equipment.
- Have the device unpacked professionally by specialized personnel.

2.2 Unpacking

Personnel: ■ Specialized personnel

Protective equipment: ■ Safety shoes
 ■ Protective gloves

1. Place the device on a level surface.
2. Unpack the device.



Keep the original packaging of your device for subsequent transportation.

3. Check the device and accessories for completeness and transport damage immediately after delivery.



If the transport packaging, device or accessories are damaged contrary to expectations, immediately inform the shipping company so that a damage report can be compiled and the transport damage inspected. Also notify the LAUDA Service department immediately. Refer to ↗ Chapter 14.4 “Contact LAUDA” on page 99 for contact details, and place/store the device in a well-ventilated location with no sources of ignition.

2.3 Operating manual catalog number

Device type	Designation	Language	Quantity	Catalog number
Versafreeze freezer cabinet	Operating manual	German	1	Q4DT-E_13-016-DE
Versafreeze freezer cabinet	Operating manual	English	1	Q4DT-E_13-016-EN
Versafreeze freezer cabinet	Operating manual	French	1	Q4DT-E_13-016-FR
Versafreeze freezer cabinet	Warranty card	----	1	----

3 Transport

3.1 Transporting the deep-freezer



WARNING!

Operating error when pushing, rollover hazard due to casters

Risk of injury from rolling over, impacts

- Do not roll the device over your feet or other parts of your body.
- Move the device carefully, ask several people to help, if necessary.
- Wear safety shoes.
- Avoid collisions with other people and objects.
- Avoid foreseeable misuse, see ↪ Chapter 1.7 “Foreseeable misuse” on page 9.

Personnel: ■ Instructed person

Protective equipment: ■ Protective gloves
 ■ Safety shoes

Note the following when pushing/moving the device:

1. Disconnect the device from the mains power.
2. Wind up the mains cable.
3. Release the locking casters.



It is advisable to have several people push/move the deep-freezer due to the device's net weight and load capacity.

Note the following when parking the device:

1. Secure the locking casters.
 - ▶ Device can be connected to the mains power supply, for further information, see ↪ Chapter 6.1 “Establishing a mains connection” on page 41.



CAUTION!

Transport damage

Cutting

- Closely inspect the device for transport damage prior to starting up.
- Never operate a device that has sustained transport damage.

! NOTICE! Setting up the device	
	Equipment damage/material damage/malfunction
	<ul style="list-style-type: none"> ● The device must be at the permissible ambient temperature when started up. If not, the device must be acclimatized.

3.2 Transport with an industrial truck

The deep-freezer can be transported using an industrial truck under the following conditions:

- The device must be secured to the industrial truck (secure load).

- Personnel: ■ Forklift driver
- Protective equipment: ■ Safety shoes
 ■ Protective gloves

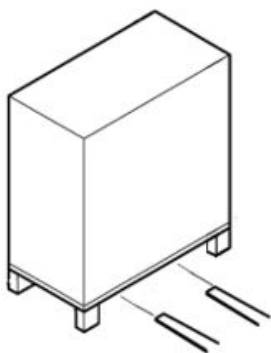

1. Only insert the forks of the industrial truck into the wider side of the device.
2. Insert the forks so far that they protrude out of the opposite side.
3. Make sure that the device cannot tip over if the center of gravity is off-center (secured load).
4. Lift the device as gently as possible and start transportation. When driving over bumps and braking, ensure that the package cannot tip or slide.
5. Always check the device for transport damage after each transport operation.

Fig. 2: Transport with an industrial truck

! DANGER! Transport damage	
	Electric shock, fire
	<ul style="list-style-type: none"> ● Closely inspect the device for transport damage prior to starting up. ● Never operate a device that has sustained transport damage. ● Always place/store a device with transport damage in a well-ventilated location with no sources of ignition.

4 Structure and function

4.1 Device function description

LAUDA Versafreeze freezer cabinets, models VF 15040, VF 60040, VF 70040 with adjustable temperature range from $-0\text{ }^{\circ}\text{C}$ to $-40\text{ }^{\circ}\text{C}$ operate with a high-performance compressor. Device models VF 15085, VF 60085, VF 70085 have two high-performance compressors that cover a temperature range of $-50\text{ }^{\circ}\text{C}$ to $-86\text{ }^{\circ}\text{C}$.

The air-cooled condenser on the back of the device releases the extracted heat from the refrigeration compartment into the ambient air.

The temperature controller keeps the preset temperature constant.

The current temperature in the cooling chamber is shown on the controller display.

Natural refrigerants are used to ensure environmentally-friendly, future-proof operation.

The device is optimized for operation at the respective maximum set temperature and also achieves maximum temperature stability (over time) at this temperature.

4.2 Structure of freezer cabinets

Front view VF 150xx



Fig. 3: Front view

1	Cover panel
2	Type plate
3	Refrigeration compartment door
4	Lock
5	Door handle
6	Castor
7	Door contactor

8	Mains switch
9	Touch operating unit

Rear view VF 150xx

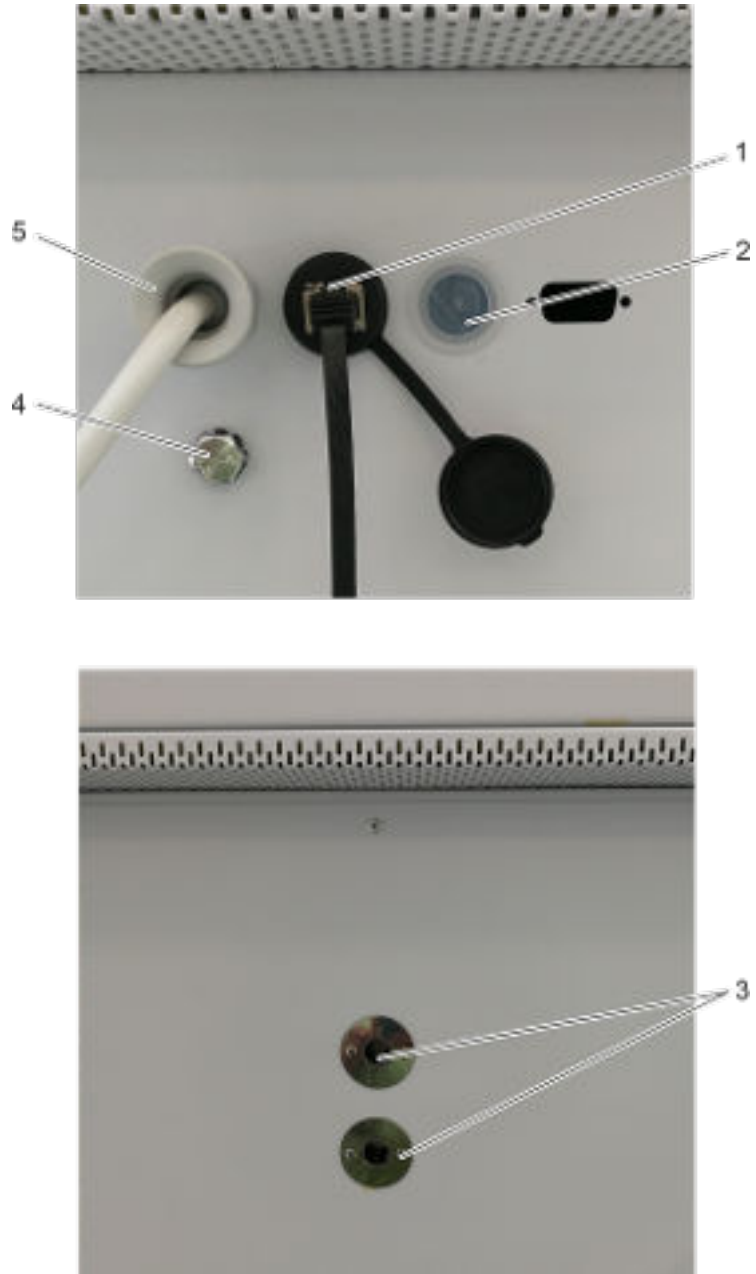

Fig. 4: Rear view

1	Interface
2	Duct
3	Ducts

4	Potential equalization
5	Mains cable

Front view VF 700xx



Fig. 5: Front view

1	Type plate
2	Touch operating unit
3	Mains switch
4	Swivel castor
5	Locking caster
6	Lock
7	Door handle

8	Refrigeration compartment door
9	Door contactor

Rear view VF 700xx



Fig. 6: Rear view

1	Ducts
2	Swivel castors

3	Mains cable
4	Cover (water cooling)
5	Condenser

Detailed rear view

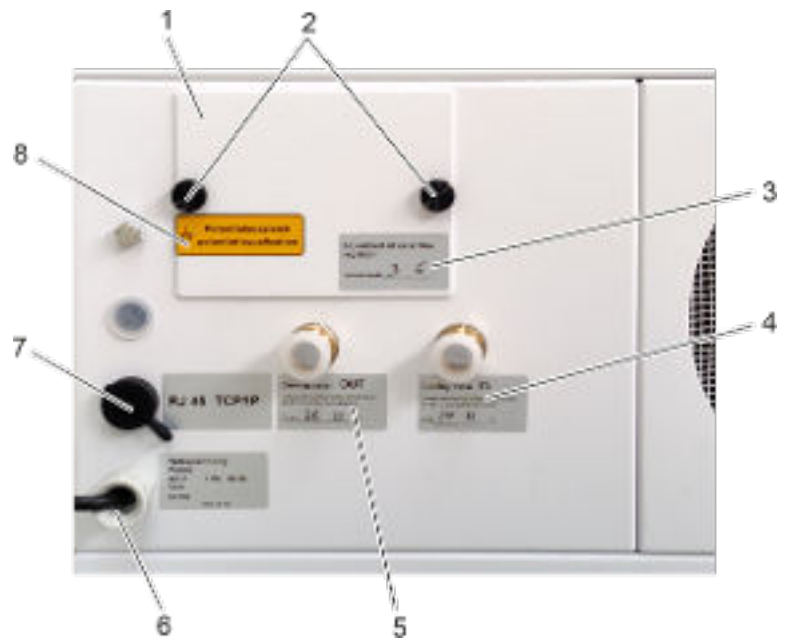

Fig. 7: Detailed view

1	Cover (water cooling)
2	Knurled screws
3	Label (cooling water volume value)
4	Cooling water connection (Cooling water IN label)
5	Cooling water connection (Cooling water OUT label)
6	Mains cable
7	Interface
8	"Potential equalization" position indication label

4.3 Undercounter installation applicable for VF 15040 and VF 15085

Removing the cover panel

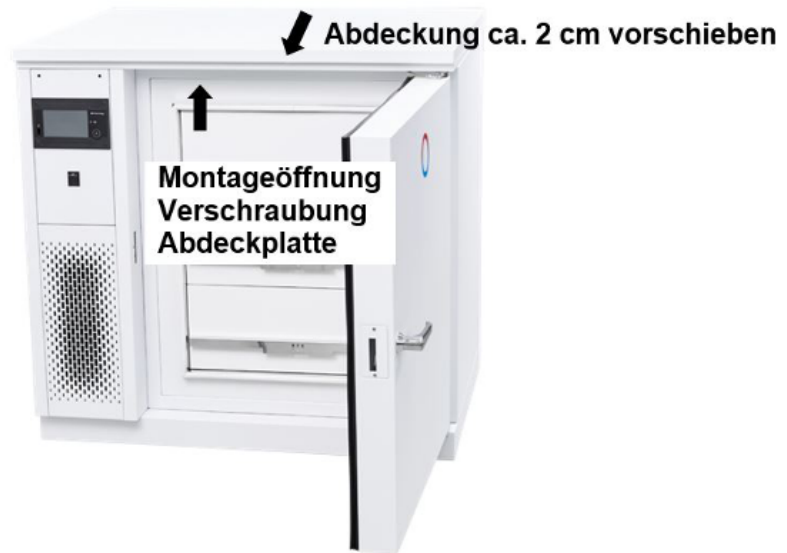

Fig. 8: Undercounter device

Before installing the freezer cabinet under a counter, the cover plate must be removed.

1. Open the device door.
2. Loosen the screw by inserting a Phillips screwdriver through the opening on the right side of the upper housing frame.
3. Pull the cover panel forward 2 cm.
 - ▶ Remove the cover panel from the device.

Minimum dimensions for the undercounter installation

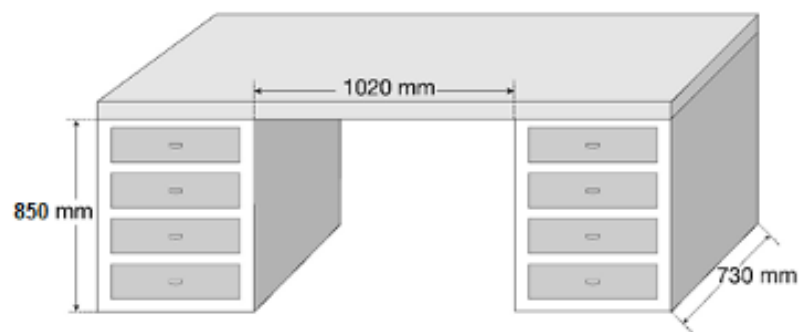

Fig. 9: Minimum dimensions

Always observe the minimum dimensions for an undercounter installation. Refer to the drawing for the minimum dimensions.

Installing the device

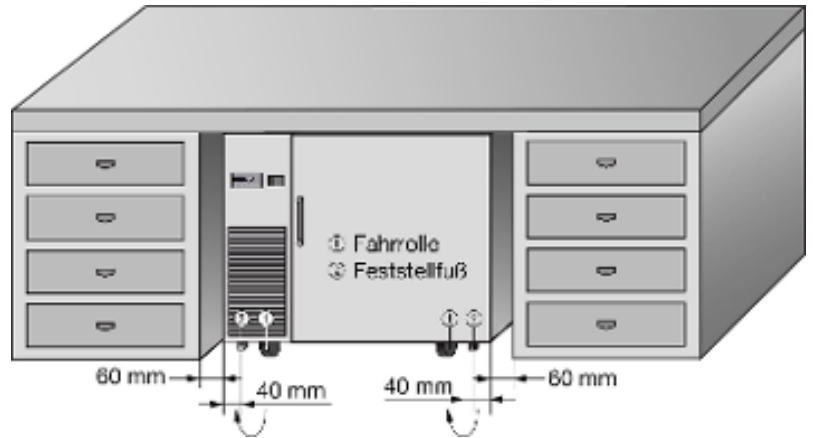

Fig. 10: Installation view

Before installing the device, always test the functionality of the electrical connection and any other connections.

Ensure that the connection cables are not damaged when installing the device.

The freezer cabinet must be installed a minimum of 60 mm away from other devices or walls so that the air drawn in for cooling purposes can circulate freely.

1. Slide the device into position with the castors fitted.
 - ▶ Once in position, secure the device using the locking castors to prevent it from moving.
 - ▶ The two locking castors are located approximately 40 mm from the device side walls at the front of the device.
2. Use the key provided to unscrew the two locking castors clockwise until the device is firmly positioned on the floor.
 - ▶ The device is now fixed in position and can no longer be moved.

4.4 Touch operating unit

General overview of Touch operating unit



Fig. 11: Touch operating unit

1	Touch operating unit display
2	Status indicator LED
3	USB interface

Touch operating unit display

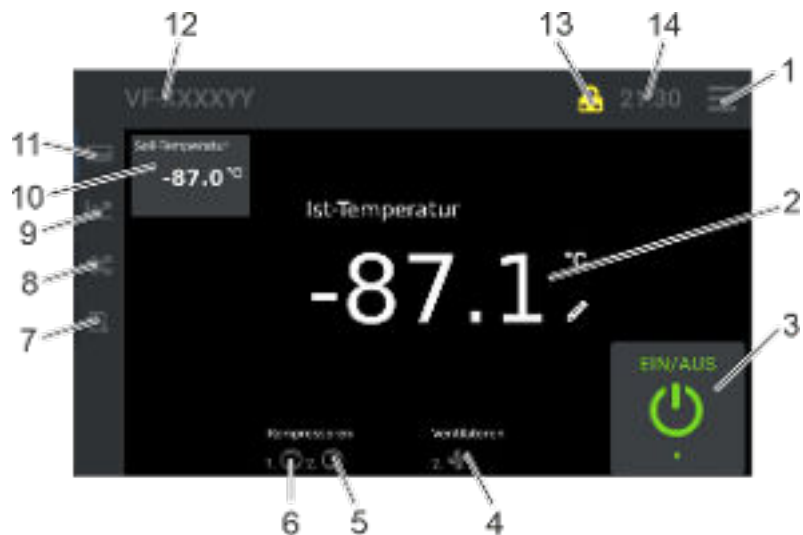
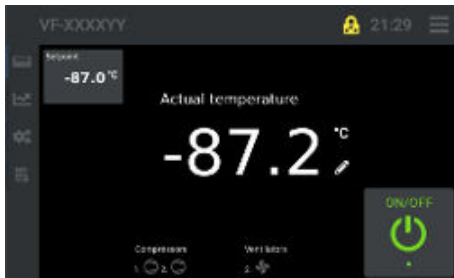
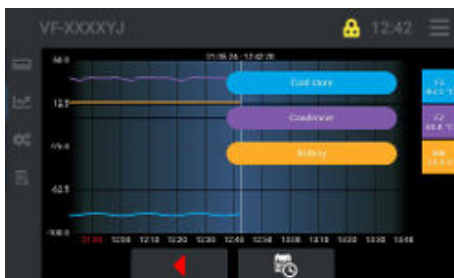

Fig. 12: Touch operating unit

1	Menu
2	Current cooling chamber temperature display
3	ON/OFF status indicator
4	Fans, rotating symbols = fan on condenser is active
5	Compressor 2, two-stage, rotating symbols = compressor is active
6	Compressor 1, single-stage, rotating symbols = compressor is active
7	History
8	Settings/controller settings
9	Internal data logger, history
10	Set point cold room temperature
11	Controller
12	Type
13	Login and user profile display
14	format



Pressing the button (11) displays the controller view.



Pressing the button (9) displays the internal data logger and history view.

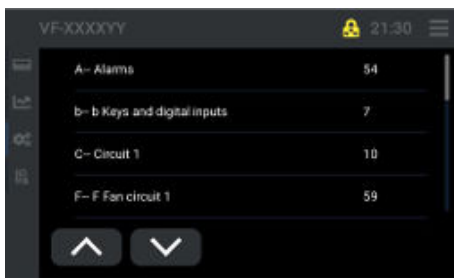

Pressing the button (8) displays the settings/controller settings view.

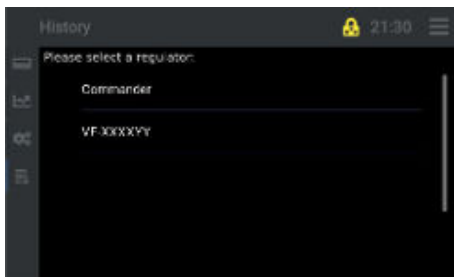

Pressing the button (7) displays the history view.

Status indicator LED

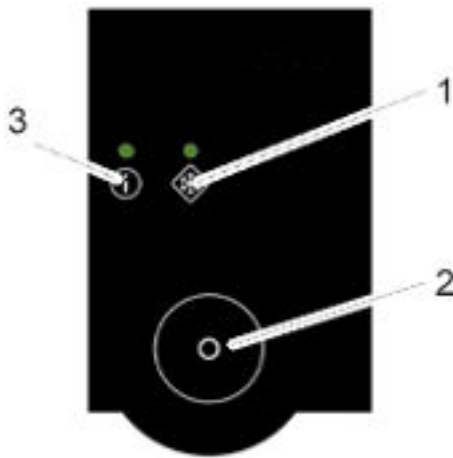

1	LED 2, auxiliary device ("SNOWFLAKE" symbol)
2	Toggle button
3	LED 1, normal cooling ("i" symbol)

Fig. 13: Status indicator LED

LED 1 (normal cooling)



Fig. 14: LED1

LED status	Description
Green	Active, no errors/faults during normal cooling
Red	All other instances, such as: <ul style="list-style-type: none"> - Connection failure - Collective fault - Standby

LED 2, only active during CO₂/LN₂ safety cooling (auxiliary device)



Fig. 15: LED2

LED status	Description
Green	Active, no errors/faults present
Yellow	Cold room temperature too high Safety cooling is on standby. Solenoid valve will become active "soon" and no errors present. "Soon" means: Cold room temperature is around the resulting set point (between lower and upper switching point) within the hysteresis range and solenoid valve is not active.
Yellow, flashing	Solenoid valve active (coolant (CO ₂ or LN ₂) is injected), no errors present. Coolant is only injected when the cover is closed.
off	Safety cooling system not connected.
Red	All other instances, such as: <ul style="list-style-type: none"> - Collective fault - Standby

4.5 Operating elements

4.5.1 Mains switch



Fig. 16: Mains switch

The mains switch can be set to the following positions:

- Position [I] switches the device on. The green indicator light is lit.
- Position [O] switches the device off. The green indicator light is off.

4.5.2 Refrigeration compartment lock



Fig. 17: Refrigeration compartment door lock, VF 150xx

1 Refrigeration compartment lock

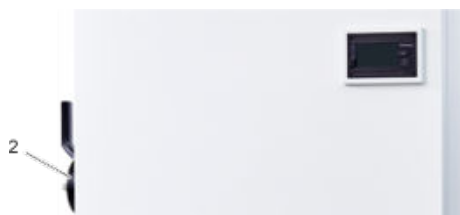

Fig. 18: Refrigeration compartment door lock, VF 600xx and VF 700xx

2 Refrigeration compartment lock

The refrigeration compartment can be locked with the key provided.

Never keep the keys near the device or within the reach of children or unauthorized persons.

4.6 Rating label

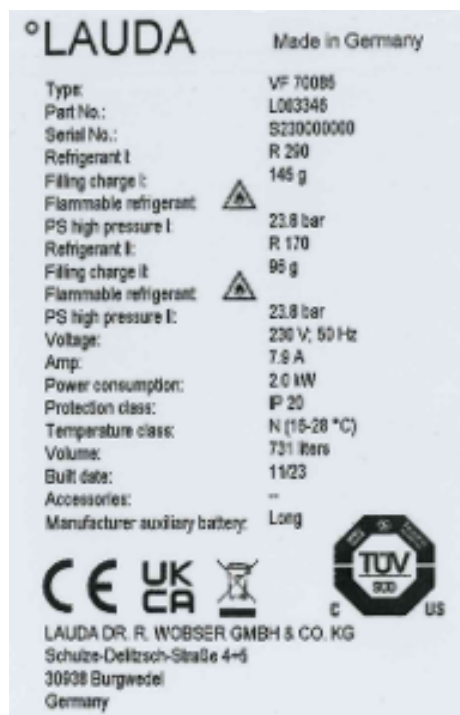

Fig. 19: Type plate (example)

Specification	Example	Description
°LAUDA	Made in Germany	Manufacturer LAUDA, manufactured in Germany
Type:	VF 70085	Device type
Part No.:	L003346	Device item number
Serial no.:	S23xxxxxxx	Serial number of the device
Refrigerant I:	R 290	Refrigerant used in refrigeration circuit 1 of the device for cooling.
Filling charge I:	145 g	Filling weight of coolant 1 in g
Flammable refrigerant:	Warning symbol	Flammable refrigerant
PS high pressure I:	23.8 bar	Maximum safety pressure in refrigerant circuit 1 in bar
Refrigerant II:	R 170	Refrigerant used in refrigeration circuit 2 of the device for cooling.
Filling charge II:	96 g	Filling weight of coolant 2 in g
Flammable refrigerant:	Warning symbol	Flammable refrigerant
PS high pressure II:	23.8 bar	Maximum safety pressure in refrigerant circuit 2 in bar
Voltage:	230 V; 50 Hz	Permissible power supply, mains voltage in V / frequency in Hz
Amp:	7.9 A	Mains fuse in A
Power consumption:	2.0 kW	Power consumption in kW
Protection class:	IP 20	Protection level / protection class
Temperature class	N (16-28°C)	Temperature class
Volume:	731 liters	Volume of refrigeration compartment in liters
Built date:	11/23	Date of manufacture, month/year
Accessories:	-	For example: CO ₂ safety cooling
Manufacturer auxiliary battery	Long	Manufacturer of the auxiliary battery

4.7 Internal data logger

The internal data logger starts automatically and records



Fig. 20: Overview

- the refrigeration compartment temperature
- the condenser temperature
- the voltage of the data logger battery (auxiliary)

every 120 seconds (which is a preset value).

Previous recordings from selectable time sequences can be loaded and viewed, see ↗ Chapter 7.8 “Internal data logger and history function” on page 65.

The data logger is equipped with a 1 GB industrial SD card which is sufficient to record data for a period of up to 2 years.

Once the memory is full, the oldest data is always overwritten first.

We recommend backing up the data every six months or more frequently, depending on the importance of the data, see ↗ Chapter 7.5 “Data transfer via USB” on page 61.

The data logger records additional data/information internally, such as

- Alarms
- Access to data and parameters
- Ambient temperatures

. This information can be viewed and evaluated on a PC using “ST-Studio” software.



Note: In order to edit data, the “ST-Studio” software must be installed on the corresponding device. The software is available free of charge from the manufacturer LAUDA. For more information, contact LAUDA Service.

4.8 Limit values USr user level, factory setting

A6	Alarm delay (device door open)	Factory setting	60 seconds
A13	Lower limit 1 (absolute/relative) (low temperature)	Factory setting	-4.0 K
A15	Upper limit 1 (absolute/relative) (over-temperature)	Factory setting	4.0 K
C11	Cold room temperature set point	Factory setting	Refer to the device card for the value
C25	Hysteresis, sensor F1	Factory setting	Refer to the device card for the value
H11	Offset correction, sensor F1	Factory setting	Refer to the device card for the value

The device card of the VF 150xx is located behind the left side cover of the machinery room. The device card of the VF 600xx and VF 700xx is located behind the right side cover of the machinery room.

5 Before starting up

5.1 Installation



WARNING!
Risk of device tipping over/rolling away

Crushing, impacts, injuries

- Do not tilt the device.
- Position the device on an even, non-slip surface with a sufficient load carrying capacity.
- Apply the castor brakes to park the device.
- Do not place heavy objects on the device.



WARNING!
Danger of overpressure from high ambient temperatures

Fire, injury, leaking refrigerant

- Note the permissible ambient temperature and storage temperature, see ↪ Chapter 12.3 “Device data” on page 81.



WARNING!
Bursting of the cooling circuit

Fire, impacts, cutting, device damage

- Always maintain the permissible ambient conditions specified in the technical data.
- In small areas, maintain the ambient temperature by providing additional room ventilation or cooling.



WARNING!
Formation of a flammable atmosphere

Fire

In the event of a refrigerant leak and/or damage to the device, note the following:

- Only certified specialized personnel are permitted to intervene in the refrigeration system and handle flammable refrigerants.
- Switch off the device and disconnect from the main power supply.
- Place/store the device in a well-ventilated location with no sources of ignition.
- Contact LAUDA Service.

! NOTICE!
Setting up the device

Equipment damage/material damage/malfunction

- The device must be at the permissible ambient temperature when started up. If not, the device must be acclimatized.

Always observe the following:

- Note the electromagnetic compatibility (EMC) requirements of the device. Refer to ↗ Chapter 1.3 “EMC requirements” on page 8 for more information.
- Check the mains cable for damage prior to starting up
- The device can be operated at an ambient temperature of 16 °C to 28 °C.
- Move/push the device with the help of several people, if necessary.
- A higher ambient temperature will have a negative impact on the device's cooling output.
- Only use the device in an acclimatized state. See Ambient temperature ↗ Chapter 12.3 “Device data” on page 81.
- Keep the device away from objects and walls and do not cover the ventilation openings.

i Refrigerant type and charge information is printed on the type plate or in the technical data.

5.2 Selecting the menu language



Fig. 21: Menu icon

1. Press the [Menu] icon.
2. Press the [Settings] button (1).



Fig. 22: Settings



Fig. 23: Settings_Language

3. Press the [Language] button (2).
 - ▶ The language selection screen opens.

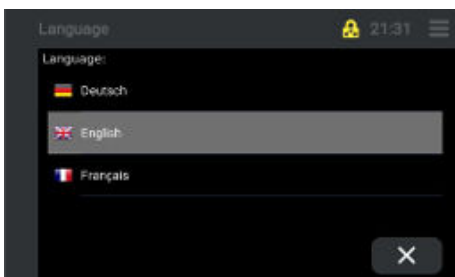

Fig. 24: Selecting a language

4. Select the language (German, English, French) on the Touch operating unit display.
 - ▶ The display view switches to the controller view.
 - ▶ After a few seconds, the display will switch to the selected language.

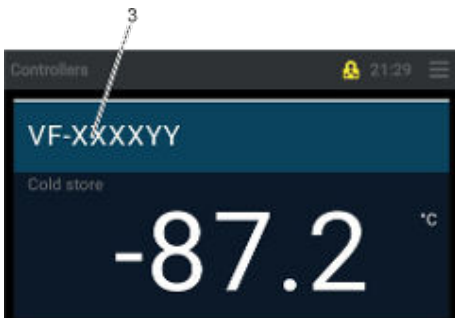

Fig. 25: Controller view

5. Press the [Type] button (3).
 - ▶ The Touch operating unit display switches to the "Home screen" view.
 - ▶ The selected language is active.

5.3 Setting the date and time



Fig. 26: Menu icon

Set or change the date and time as follows.

1. Press the [Menu] icon.

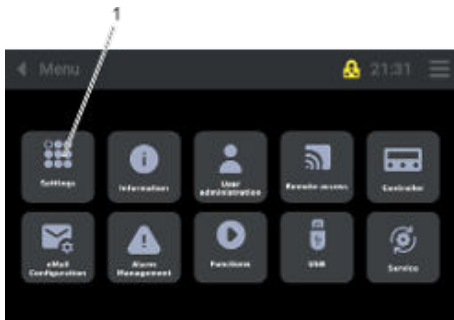

Fig. 27: Settings



Fig. 28: Settings_Date/Time

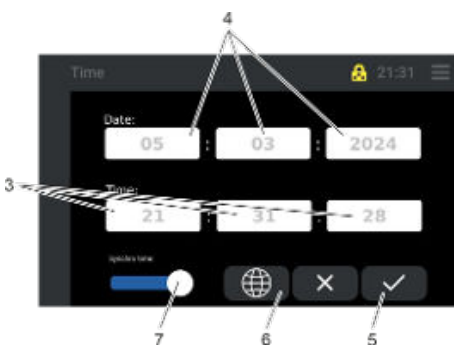

Fig. 29: Date/Time

2. Press the [Settings] button (1).

3. Press the [Date/Time] button (2).

▶ The display view for changing the date/time opens.

4. When individual buttons (3) and (4) are pressed, a numeric keypad appears.

▶ Enter relevant values for the date and time.

5. Press the button (5) to confirm.

6. When the button (6) is pressed, a window displaying all the time zones opens.

▶ Time zones can be selected/set without an Internet connection.

▶ Select the time zone and confirm.

7. Pressing the button (7) synchronizes the time automatically.

▶ In this case, the device must be connected to the Internet/Cloud.

▶ The time has synchronized automatically.

5.4 Setting the temperature unit



Fig. 30: Menu icon

Set or change the temperature unit as follows:

1. Press the [Menu] icon.

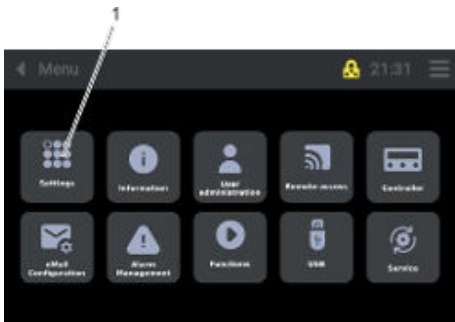

Fig. 31: Settings

2. Press the [Settings] button (1).



Fig. 32: Settings_Temperature Unit

3. Press the [Temperature Unit] button (2).
 - ▶ A new display view opens.



Fig. 33: Temperature unit

4. Select the required unit by pressing the corresponding button (3).
5. Press the button (4) to confirm.
 - ▶ The selected unit is active.

5.5 Changing the record interval for the internal data logger

When the device is delivered, the default value is 120 seconds. Selecting a record interval that is too short will require the storage of a large amount of data and is therefore not recommended.

Change the record interval for the internal data logger as follows:

1. Press the [Menu] icon.



Fig. 34: Menu icon

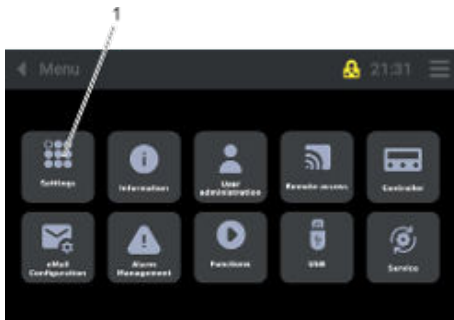

Fig. 35: Settings

2. Press the [Settings] button (1).



Fig. 36: Settings_Record interval

3. Press the [Record interval] button (2).
 - ▶ A new display view opens.

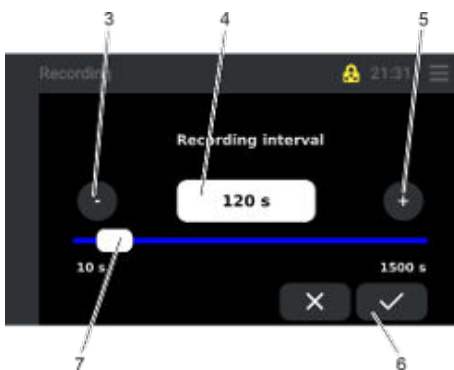

Fig. 37: Recording interval

4. Set the relevant time (10 to 1500 seconds) by moving the slide button (7), pressing the [+] (5) and [-] (3) buttons, or entering the value directly (4).
5. Press the button (6) to confirm.
 - ▶ The selected record interval is active.

5.6 Changing the plant name



Fig. 38: Menu icon

Change the plant name as follows:

1. Press the [Menu] icon.

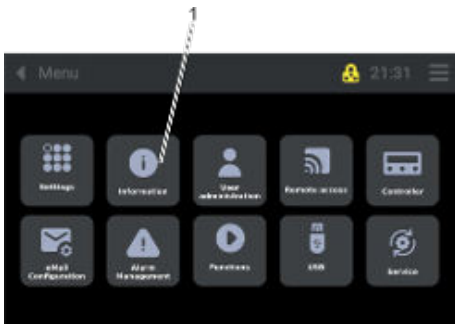

Fig. 39: Information

2. Press the [Information] button (1).

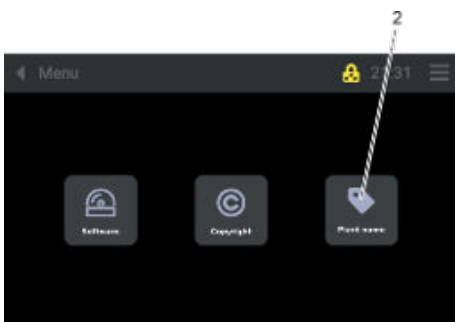

Fig. 40: Information_Plant name

3. Press the [Plant name] button (2).
 - ▶ A keyboard appears.



Fig. 41: Keyboard

4. Change the plant name and press the button (3) to save.
 - ▶ The new plant name is active.

5.7 Displaying software information



Fig. 42: Menu icon

Display the software information as follows:

1. Press the [Menu] icon.

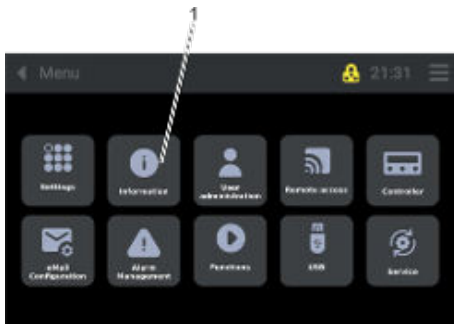

Fig. 43: Information

2. Press the [Information] button (1).

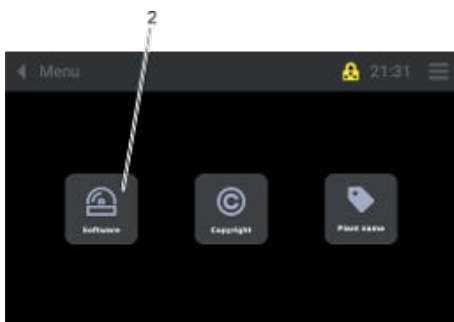

Fig. 44: Information_Software

3. Press the [Software] button (2).
 - ▶ A list of software information appears.



Fig. 45: Software

4. Scroll through the software list using the buttons (3).

5.8 Displaying copyright information



Fig. 46: Menu icon

Display the copyright information as follows:

1. Press the [Menu] icon.

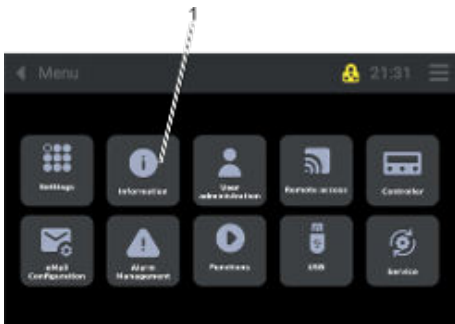

Fig. 47: Information

2. Press the [Information] button (1).

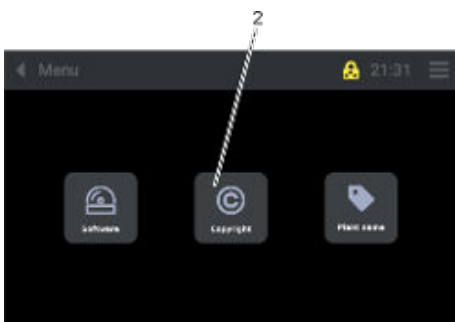

Fig. 48: Information_Copyright

3. Press the [Copyright] button (2).
 - ▶ A list of copyright information appears.

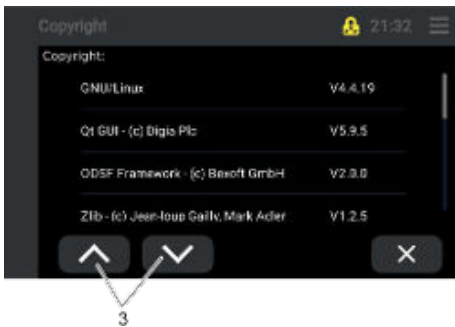

Fig. 49: Copyright

4. Scroll through the copyright list using the buttons (3).

6 Commissioning

6.1 Establishing a mains connection



DANGER!

Risk of short circuit due to failure to observe the acclimatization time

Electric shock

- Allow a "cold" device to first acclimatize to the ambient temperature.
- Wait until the device reaches the ambient temperature before connecting it to the power supply and starting it up.
- Ambient temperatures, see chapter "Technical data".



DANGER!

Transport damage

Electric shock

- Closely inspect the device for transport damage prior to commissioning!
- Never operate a device that has sustained transport damage!



WARNING!

Contact with voltage conductors due to faulty mains cable and/or safety plugs

Electric shock

- Before using the mains cable and safety plug, check that they are in perfect condition.
- Never use a faulty mains cable or safety plug to power the device.
- The mains cable and safety plug must not come into contact with any refrigerated surfaces on the device, neither during operation nor after switching off.



NOTICE! Use of impermissible mains voltage or mains frequency

Device damage

- Compare the type plate with the available mains voltage and mains frequency.
- Only connect to the power supply if the specifications are compliant.
- The main switch must be set to position "0" [Off].
- The power supply must be correctly installed with a protective earth conductor (PE).
- Local regulations must be observed.

Please note the following:

- Note for electric installation on site:
 - Device models VF 15040, VF 15085, VF 60040, VF 60085, VF 70040 and VF 70085 must be protected on the installation side (mains fuse on site) by a circuit breaker (maximum 16 amperes).
 - Device models VF 60085 and VF 70085 with an electrical connection of 115 V/60 Hz must be protected on the installation side (mains fuse on site) by a circuit breaker (maximum 30 amperes)
- Refer to the type plate or technical data for connection values.
- Only use the supplied power cable with safety plug to connect to the power supply.
 - For device models VF 15040, VF 15085, VF 60040, VF 60085, VF 70040 and VF 70085 with the electrical connection value 230 V/50 Hz, the following part is included in the scope of delivery of the device:
 - For Switzerland: Adapter fixed connection T23 SEV 5934/2 (16A)
 - For UK: Adapter GB 13A, BS 1363
- Only connect the device to power sockets with a protective earth conductor (PE).
- Operate the device according to local regulations.

6.2 Switching the device on and off

Switching on the device



Fig. 50: Mains switch

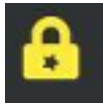

Fig. 51: User icon

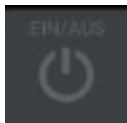

Fig. 52: ON/OFF icon

Switching off the device

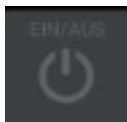

Fig. 53: ON/OFF icon



Fig. 54: Mains switch

1. Set the mains switch to the "I" position, see [Chapter 4.5.1 "Mains switch"](#) on page 29.
 - ▶ Once the device has started up (after approximately 5 seconds), the overtemperature alarm [Tmax 1] is shown on the Touch operating unit display and the alarm signal sounds.

Note:

An alarm can only be acknowledged from the "User" user profile onward, see [Chapter 6.4 "Selecting a user profile"](#) on page 45 and [Chapter 6.3 "Defining user profiles"](#) on page 44.

2. Acknowledge the alarm message on the Touch operating unit display, see [Chapter 7.7 "Resetting an alarm"](#) on page 65.
3. Press the [ON/OFF] tile on the Touch operating unit, see [Chapter 4.4 "Touch operating unit"](#) on page 25.
 - ▶ The device is switched on.

1. Press the [ON/OFF] tile on the Touch operating unit, see [Chapter 4.4 "Touch operating unit"](#) on page 25.

2. Set the mains switch to the [O] position, see [Chapter 4.5.1 "Mains switch"](#) on page 29.

Instructions for switching off:

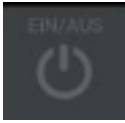

Fig. 55: ON/OFF icon

1. If you intend to switch off the device for longer periods, press the [ON/OFF] tile on the Touch operating unit.
 - ▶ [OFF] appears on the display
2. Set the mains switch to the "O" position, see ↪ Chapter 4.5.1 "Mains switch" on page 29.

If the device is switched off at the mains switch, the "power failure" alarm is triggered and the device records the temperature for approximately 35 hours, powered by the battery of the internal data logger.

6.3 Defining user profiles

"Guest" user profile



Fig. 56: Guest icon

The device is started with the "Guest" user ID.

All data relevant to device operation can be accessed in this level.

The device cannot be switched on or off in this user level.

Settings cannot be changed in this level.

The default password is "Guest".

"User" user profile

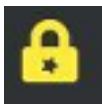

Fig. 57: User icon

Individuals logging in with the "User" user ID can change settings such as the set point of the cooling chamber temperature or the alarm delay for the door.

The default password is "User".

"Service" user profile



Fig. 58: Service icon

Under the "Service" user ID, the operator/user can change more settings than in the "User" level including changing parameters or the limit of set point temperatures as well as transferring data via USB, for example.

The default password is "Service".

"Admin 1" user profile



Fig. 59: Admin 1 icon

All settings can be modified under the "Admin 1" user ID, such as those required to integrate the device into the operator's IT landscape.

The default password is "Admin 1".

6.4 Selecting a user profile



Fig. 60: Login and user profile display



Fig. 61: User profiles



Fig. 62: Keyboard

6.5 Changing the user profile password

1. Press the [Login and user profile display] icon on the operating unit.
 - ▶ The display switches to the "Login" overview.

2. Select the required user profile (Admin 1, Guest, Service or User).
 - ▶ A keyboard appears.

3. Use the keyboard to enter the password for the selected user profile.
4. Press the [Save] button (2).
 - ▶ The selected user profile is active.
5. It is also possible to log out a selected user by pressing button (1).

For more information about the different user profiles, see [Chapter 6.3 "Defining user profiles"](#) on page 44.

In a user profile, only the passwords for this level and the levels below can be changed.

"Admin 1" can change any password, while a "User" can only change the passwords for a subordinate "Guest".

The number of stars in the yellow padlock on the Touch operating unit display indicates which user profile is currently active.

User profile type	Number of stars in the padlock
Admin 1	3
Service	2
User	1
Guest	-

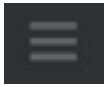

Fig. 63: Menu icon

1. Press the [Menu] icon on the operating unit.
 - ▶ The menu overview opens.

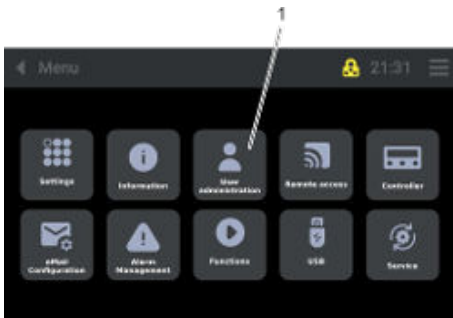

Fig. 64: User administration

2. Press the [User administration] button (1).

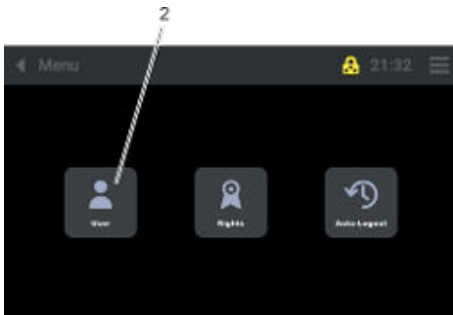

Fig. 65: User administration_User

3. Press the [User] button (2).
 - ▶ The "User" overview opens.



Fig. 66: User overview

4. Press the button (4) to scroll down in the user overview and press the button (3) to scroll up in the menu.



Fig. 67: User overview

5. Select the user. Press the [Edit] button (5).
 - ▶ A keyboard appears.



Fig. 68: Keyboard

6. Enter the "new" password using the keyboard and save by pressing the button (6).
 - ▶ The password has been changed.
7. Pressing the [Previous level] button (7) changes the view.
 - ▶ The display switches to the "Home screen" view.

6.6 Creating a new user name



Fig. 69: Menu icon

1. Press the [Menu] icon on the operating unit.
 - ▶ The menu overview opens.

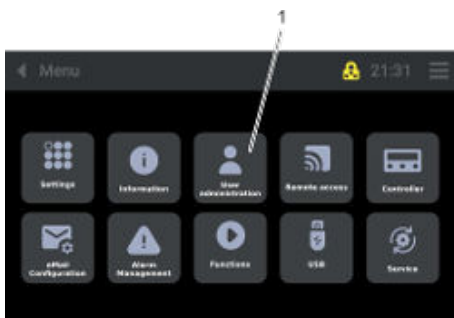

Fig. 70: User administration

2. Press the [User administration] button (1).



Fig. 71: User administration_User

3. Press the [User] button (2).
 - ▶ The "User" overview opens.



Fig. 72: User overview

4. Press the button (3).
 - ▶ A keyboard appears.



Fig. 73: Keyboard

5. Enter the "new" user name using the keyboard and save by pressing the button (4).
 - ▶ The new user name has been created.
 - ▶ Now the user profile rights must be configured, see ↗ Chapter 6.7 "Configuring user profile rights" on page 48.

6.7 Configuring user profile rights

The "Configure user rights" function can only be activated from the "Admin 1" user profile.

1. Press the [Menu] icon on the operating unit.



Fig. 74: Menu icon

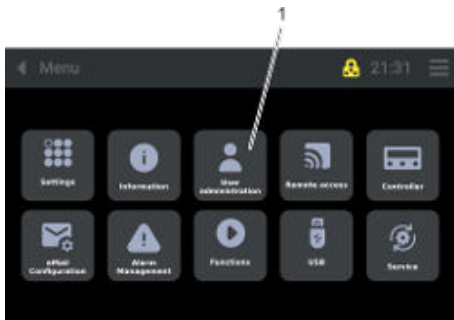

Fig. 75: User administration

2. Press the [User administration] button (1).

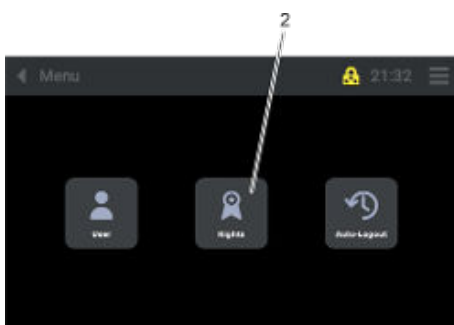

Fig. 76: User administration_Rights

3. Press the [Rights] button (2).
 - ▶ The "Rights" overview opens.

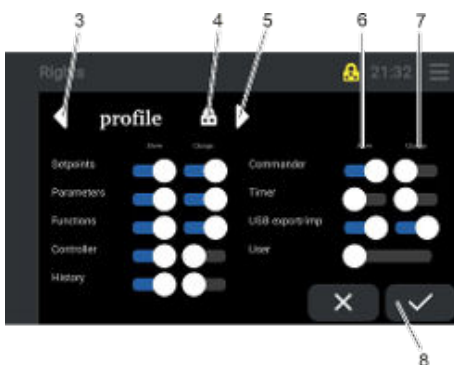

Fig. 77: Profiles

4. You can navigate through the various created profiles by pressing the button (3) or (5).
 - ▶ The display (4) shows which user profile is currently active.
5. Profile rights can be configured/changed by moving the Display (6) and/or Change (7) slide buttons.
6. Press the [Save] button (8).
 - ▶ The profile rights for the current user profile (4) are saved.

6.8 Activating auto logout

To prevent unwanted access to the device controller, the "Auto Logout function" can be activated to protect the Touch control element.

When the "Auto logout function" is activated, the Touch control element automatically reverts back to the "Guest profile", which means that it is no longer possible to adjust the temperature or switch off the device.

The "Auto logout" function can only be activated from the "Service" and "Admin 1" user profiles, see also ↪ Chapter 6.3 "Defining user profiles" on page 44.

1. Press the [Menu] icon on the operating unit.



Fig. 78: Menu icon

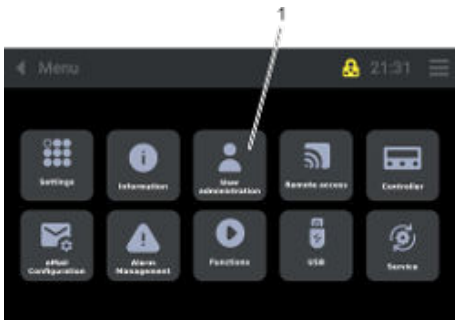

Fig. 79: User administration

2. Press the [User administration] button (1).

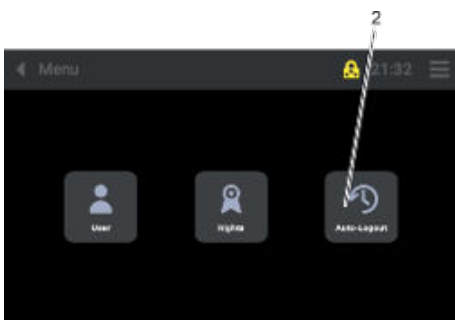

Fig. 80: User administration_Auto_Logout

3. Press the [Auto logout] button (2).
 - ▶ The "Auto logout" overview opens.

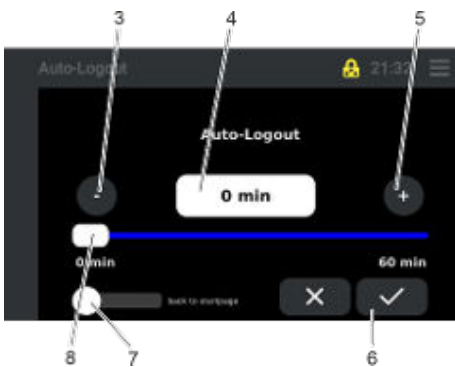

Fig. 81: Auto logout

4. Set the relevant time (1 to 60 minutes) by moving the slide button (8), pressing the [+] (5) and [-] (3) buttons, or entering the value directly (4).
5. Press the [Save] button (6).
6. After moving the "Back to home page" slider button (7), the display view changes to the "Controller" view once the set time has elapsed.
 - ▶ "Auto logout" is activated for the preset time.

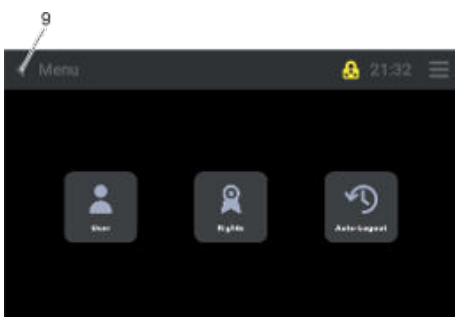

Fig. 82: Menu

7. When the button (9) is pressed, the display reverts back to the "Controller" view.

6.9 Selecting and displaying control curves



Fig. 83: Data logger icon

1. Press the [Data logger] icon on the Touch operating unit.
 - ▶ The control curve overview opens.



Fig. 84: Control curves – Control curve screen

Briefly tap button [F1] (1), [F2] (2) or [Bat] (3) to display their designation to the left of the buttons.

All three control curves are selected by default.

To display only one control curve, the other control curves must be deactivated.

To deactivate a control curve, press and hold the corresponding symbol for approximately 3 seconds. The symbol will then turn white and the control curve will disappear.

To activate the control curve, press and hold the deactivated white symbol for approximately 3 seconds until it changes back to its original color.

- Blue (F1) = Cold store (refrigeration compartment temperature)
- Violet (F2) = Condenser (condenser temperature)
- Orange (Bat) = Battery (voltage of the internal auxiliary battery)

6.10 Setting alarm limit values

For additional information on "Alarms, warnings and errors", see also the "Faults" chapter, ↪ Chapter 9.1 "Alarms, warnings and errors" on page 76.

6.10.1 Setting the alarm delay limit value for the device lid

When the device lid is opened, a timer starts. If the preset delay time is exceeded, the device lid alarm is triggered. For information on the factory preset value for the alarm delay, see also ↪ Chapter 4.8 "Limit values USr user level, factory setting" on page 31.



Fig. 85: Menu icon

1. Press the [Menu] icon on the operating unit.

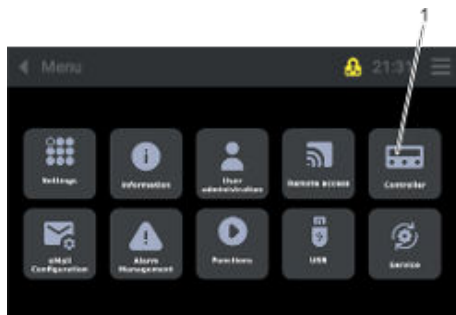

Fig. 86: Controller

2. Press the [Controller] button (1).



Fig. 87: Controller_Parameters

3. Press the [Parameters] button (2).



Fig. 88: Controller_Parameters_Controller type

4. Select the controller by pressing the button (3).



Fig. 89: Alarms

5. Press the [A-alarms] button (4).

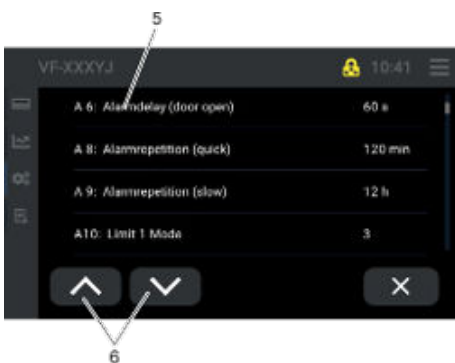

Fig. 90: Alarm message A6

6. Press the buttons (6) to scroll to the relevant alarm message.

7. Press the button (5) to select the alarm message (A6).

▶ The window for modifying the alarm delay opens.

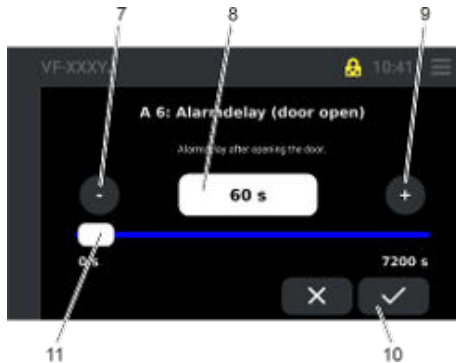

Fig. 91: Alarm message A6_Changing the setting value

8. Set the relevant time (0 to 7200 seconds) by moving the slide button (11), pressing the [+] (9) and [-] (7) buttons, or entering the value directly (8).
9. Press the [Save] button (10).
 - ▶ The new device lid time delay is active.

6.10.2 Setting a limit value for the low temperature alarm

If the cold room temperature falls below the factory preset lower limit value (absolute/relative), the low temperature alarm is triggered. Default value, see also ↗ Chapter 4.8 “Limit values USr user level, factory setting” on page 31.

1. Press the [Menu] icon on the operating unit.



Fig. 92: Menu icon

2. Press the [Controller] button (1).

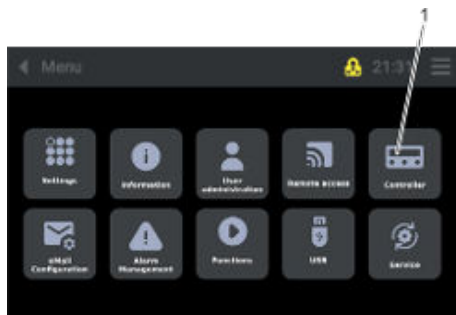

Fig. 93: Controller

3. Press the [Parameters] button (2).



Fig. 94: Controller_Parameters



Fig. 95: Controller_Parameters_Controller type

4. Select the controller by pressing the button (3).



Fig. 96: Alarms

5. Press the [A-alarms] button (4).



Fig. 97: Alarm message A13

6. Press the buttons (6) to scroll to the relevant alarm message.
7. Press the button (5) to select the alarm message (A13).
 - ▶ The window for modifying the limit value opens.

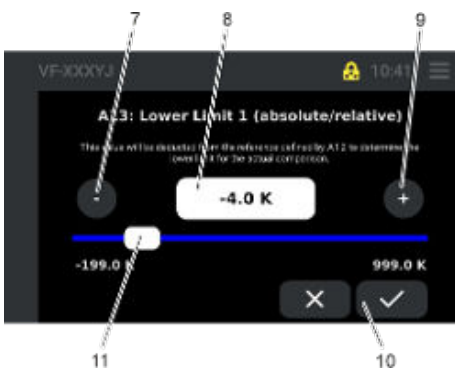

Fig. 98: Alarm message A13_Changing the limit value

8. Set the relevant temperature difference (-199 K to 999 K) by moving the slide button (11), pressing the [+] (9) and [-] (7) buttons, or entering the value directly (8).
The temperature difference value must be "negative" (-).
9. Press the [Save] button (10).
 - ▶ The modified lower limit value (absolute/relative) is active.

6.10.3 Setting a limit value for the overtemperature alarm

If the cold room temperature exceeds the factory preset upper limit value (absolute/relative), the overtemperature alarm is triggered. Default value, see also ↗ Chapter 4.8 “Limit values USr user level, factory setting” on page 31.

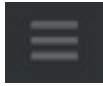

Fig. 99: Menu icon

1. Press the [Menu] icon on the operating unit.

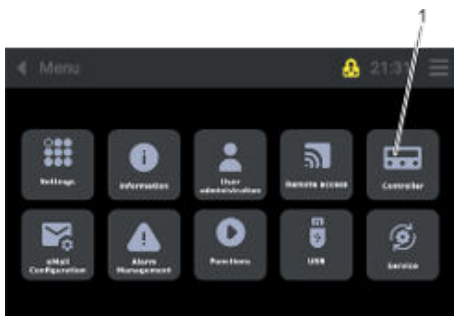

Fig. 100: Controller

2. Press the [Controller] button (1).

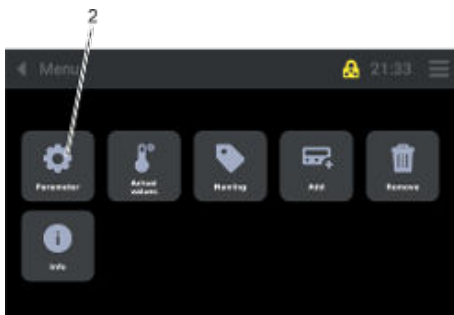

Fig. 101: Controller_Parameters

3. Press the [Parameters] button (2).



Fig. 102: Controller_Parameters_Controller type

4. Select the controller by pressing the button (3).



Fig. 103: Alarms

5. Press the [A-alarms] button (4).

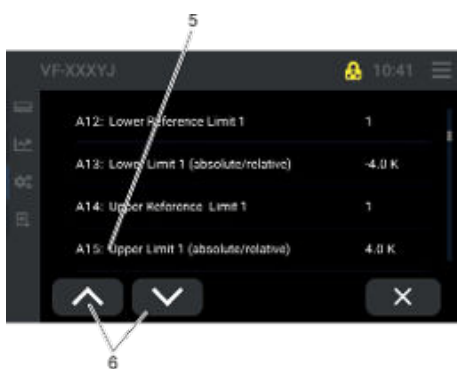

Fig. 104: Alarm message A15

6. Press the buttons (6) to scroll to the relevant alarm message.
7. Press the button (5) to select the alarm message (A15).
 - ▶ The window for modifying the limit value opens.

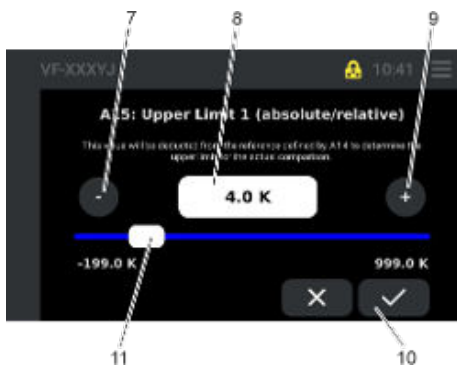

Fig. 105: Alarm message A15_Changing the limit value

8. Set the relevant temperature difference (-199 K to 999 K) by moving the slide button (11), pressing the [+] (9) and [-] (7) buttons, or entering the value directly (8).

The temperature difference value must be "positive" (+).
9. Press the [Save] button (10).
 - ▶ The modified upper limit value (absolute/relative) is active.

7 Operation

7.1 Safety information

7.1.1 General safety instructions



DANGER! Short circuit due to water in the main switch

Electric shock

- Prevent liquids from entering the electrical components inside the device.
- Protect the device from splash water.
- Observe the protection level and protection class specified for the device.



WARNING! Storage of dangerous goods

Personal injury, risk of explosion

- Do not store:
 - Acids and alkalis that can attack materials
 - Hazardous substances that emit harmful fumes
 - Substances that are highly flammable and/or explosive



WARNING! Risk of mechanical damage to refrigerant circuit

Leaking flammable refrigerant generates an explosive atmosphere
Explosion, burns, fire

- Ventilate the room thoroughly without delay.
- During this period, do not operate any switches on the device or anywhere else in the room.
- Do not ignite flames or sparks and refrain from smoking.



CAUTION! Risk of mechanical damage to refrigerant circuit

Hazard to health through inhalation (TLV values exceeded)

- Ventilate the room thoroughly without delay.
- During this period, do not operate any switches on the device or anywhere else in the room.
- Do not ignite flames or sparks and refrain from smoking.

7.2 Adjustment of the cooling chamber temperature set point



Fig. 106: Touch operating unit

After the device is switched on at the mains switch, see Chapter 4.5.1 “Mains switch” on page 29, and on the Touch operating unit, see Chapter 4.4 “Touch operating unit” on page 25, the display shows the current temperature (2) in the cold room.

The temperature controller switches the compressors on.

The cooling process starts to bring the temperature in the cooling chamber up to the set point.

The cooling chamber temperature indicator remains red until the set point is reached. When the set point has been reached, the indicator turns white. If there is a fault on the device, the indicator switches back to red.



Fig. 107: Cooling chamber temperature set point icon

1. Press the [Cold room temperature set point] button (1).
 - ▶ The window for setting the "Cooling chamber temperature set point" opens.

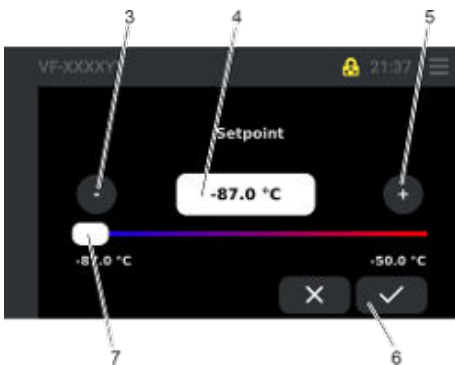

Fig. 108: Set point setting

2. Set the relevant cold room temperature by moving the slide button (7), pressing the [-] (3) and [+] (5) buttons, or entering the value directly (4).
3. Press the [Save] button (6).
 - ▶ The set point has been set and saved.

7.3 Storing and retrieving refrigerated goods

CAUTION!
Missing protective equipment

Personal injury, risk of frostbite

If the temperature in the refrigeration compartment is low, take the following measures:

- Always wear suitable cold protection gloves when storing and retrieving refrigerated goods.
- Arms must also be covered.

CAUTION!
Individuals shorter than 1.70 m are not permitted to operate or set up the device

Personal injury, ergonomic impairment

- Use a step-up stool when storing and retrieving refrigerated goods.

- Personnel:
- Specialized personnel
 - Instructed person
- Protective equipment:
- Cold protection gloves
 - Safety shoes

- Always wear safety gloves that protect the hands from cold temperatures when storing and retrieving refrigerated goods. Arms must also be covered.
- Depending on your height, it may be necessary to use a step-up stool to load and unload refrigerated goods.
- Only store refrigerated goods that meet the requirements for intended use, see ↪ Chapter 1.5 “Intended use” on page 8.
- Do not store refrigerated goods that do not meet the requirements for intended use, see ↪ Chapter 1.6 “Unintended use” on page 9.

7.4 Alarm management



Fig. 109: Menu icon

1. Press the [Menu] icon.



Fig. 110: Alarm management

2. Press the [Alarm management] button (1).

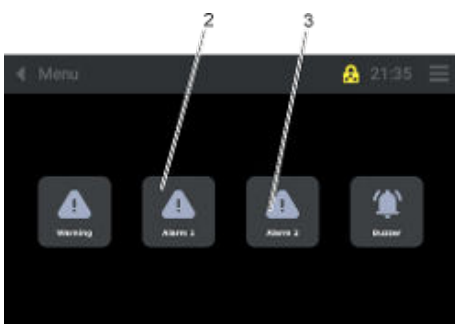

Fig. 111: Alarm management_Alarm 1 or Alarm 2

3. Select the [Alarm 1] (2) or [Alarm 2] (3) button.
 - ▶ The display switches to the "Alarm 1" or "Alarm 2" view.



Fig. 112: Alarm 1

4. Press the [Add] button (4).
 - ▶ The display switches to the "Controller" view.



Fig. 113: Alarm - Controller

5. Select the "Type" (5).

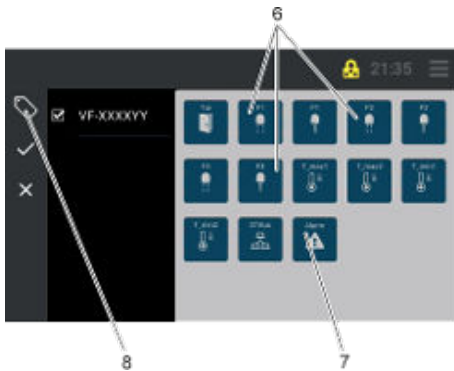

Fig. 114: Alarm_New configuration

6. It is possible to select individual "alarms" (6) or to select all alarms by pressing the [Alarm] button (7).

- Door = door alarm
- F1 = Cable break on sensor F1
- F1 = Short circuit on sensor F1
- F2 = Cable break on sensor F2
- F2 = Short circuit on sensor F2
- F3 = Cable break on sensor F3 - not assigned
- F3 = Short circuit on sensor F3 - not assigned
- T_max 1 = Temperature value is greater than A15
- T_max 2 = Temperature value is greater than A25
- T_max 1 = Temperature value is lower than A13
- T_max 2 = Temperature value is lower than A23
- STBus = Communication error
- Alarm = List of all alarms

7. Press the [Enter] button (8).

- ▶ A keyboard appears for inputting values.

8. Enter a name for the "New configuration" and press the button (9) to save.

- ▶ The display view opens with the created name.



Fig. 115: Keyboard

9. An existing alarm message can be sent directly by email by pressing the button (10).

- ▶ The "Recipient view" opens

10. When the "Recipient", "Subject" or "Delay" button is tapped, a keyboard appears. Enter the relevant data and confirm.

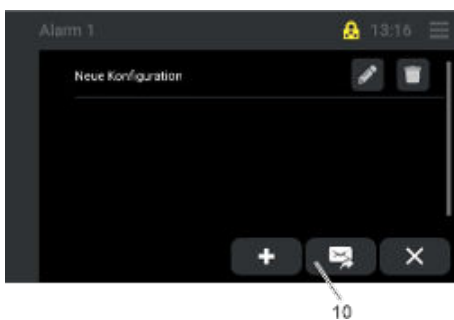

Fig. 116: Sending an alarm

7.5 Data transfer via USB

Data can only be transferred via USB if the "Service" or "Admin 1" user profile is selected.



Note: In order to edit data, the "ST-Studio" software must be installed on the corresponding device. The software is available free of charge from the manufacturer LAUDA. For more information, contact LAUDA Service.

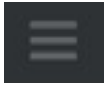

Fig. 117: Menu icon

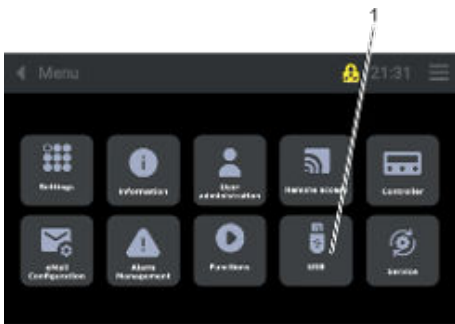

Fig. 118: USB



Fig. 119: USB_Export history

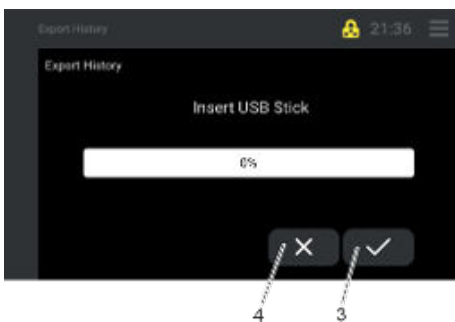

Fig. 120: Inserting the USB stick

When exporting data using a USB stick, please note the following:

- Use a USB stick with 16 GB or 32 GB of storage (manufacturer recommendation). The storage on the USB stick used cannot exceed 64 GB.
- Perform standard formatting, do not carry out fast formatting.
- Use format "FAT 32".

1. Press the [Menu] icon.

2. Press the [USB] button (1).

3. Press the [Export history] button (2).

4. Insert the USB stick.

- ▶ The system recognizes the USB stick.

5. Press the save icon (3).

- ▶ Data is transferred to the USB stick.

6. When the data transfer is complete, press the [Cancel] button (4).

- ▶ Data is loaded onto the USB stick.

- ▶ Remove the USB stick.

7.6 Setting up an Internet connection for forwarding alarms

By setting up an email server, "alarms" can be sent by email to different email addresses.



Sending alarm messages via email requires an Ethernet connection.

Furthermore, the user profile "Admin 1" must also be selected.

7.6.1 Setting up email addresses



Fig. 121: Menu icon

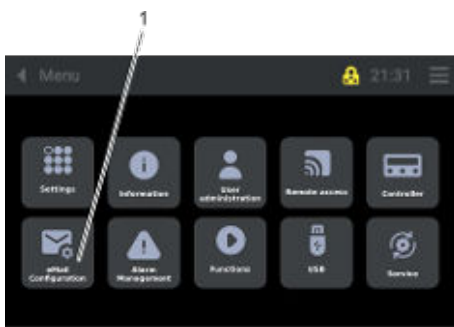

Fig. 122: eMail Configuration



Fig. 123: Address book

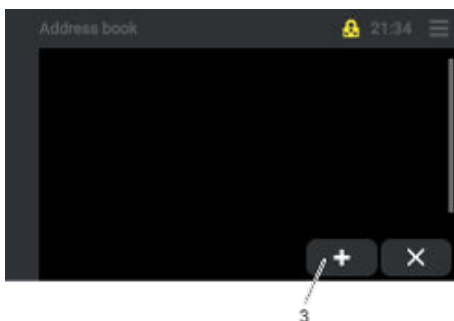

Fig. 124: Add

1. Press the [Menu] icon.
2. Press the [eMail configuration] button (1).
3. Press the [Address book] button (2).
 - ▶ The address book opens. A list of available recipients appears.
4. Press the [+] button (3).
 - ▶ The "Recipient" window opens.

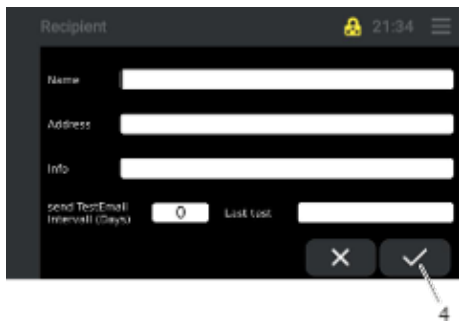

Fig. 125: Recipient

5. When the "Name", "Email address", "Comment", "Interval" or "Last test" button is tapped, a keyboard appears. Enter the relevant data and confirm.
6. Then press the button (4) to save the "Recipient view".
 - ▶ The entered email recipient is saved.
7. To enter the names of other recipients who should receive notification of an alarm, repeat steps "4" to "6".

7.6.2 Setting up an email server configuration

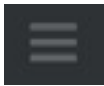

Fig. 126: Menu icon

1. Press the [Menu] icon.
2. Press the [eMail configuration] button (1).



Fig. 127: Email configuration

3. Press the [eMail server] button (2).



Fig. 128: Email server



Fig. 129: Email server

4. When the input fields are tapped, a keyboard appears. Enter the relevant data and confirm.
5. Then press the button (3) to save the "Email server view".
 - ▶ The entered email server data is saved.

To enter the required data, contact the responsible IT department or the email provider.



Fig. 130: Email server

6. Pressing the button (4) changes the display directly to the "Recipient list". From here, you can select a recipient and send an alarm message.

7.7 Resetting an alarm

In the event of a malfunction, an alarm is triggered.

When an alarm is triggered, an acoustic alarm sounds and a visual alarm appears in an alarm window.

The "Reset alarm" function can only be executed from the "User" user profile.

Disabling the acoustic alarm and rectifying the cause of the alarm



Fig. 131: Alarm icon

1. Acknowledge the alarm in the alarm window.
 - ▶ The alarm screen closes.
 - ▶ A red alarm symbol is displayed at the top of the Touch operating unit.
 - ▶ The alarm symbol disappears automatically once the alarm has been cleared, see also List of faults ↗ Chapter 9.1 "Alarms, warnings and errors" on page 76.

7.8 Internal data logger and history function



Fig. 132: Data logger icon

1. Press the [Data logger, history] icon.
 - ▶ "Controller 1" view opens.



Fig. 133: Data logger

2. Press the button (1).
 - ▶ An overview of time periods opens.

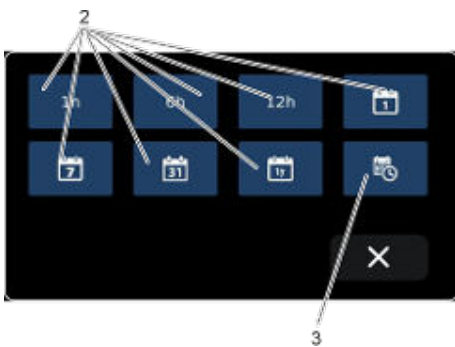

Fig. 134: Selecting a time period

3. Select the required time period by pressing the relevant button (2).
 - ▶ The temperature profile is displayed.
4. To retrieve past records, press the [History] button (3).
 - ▶ A window for setting the "from" / "to" date opens.

1h = 1 hour
 6h = 6 hours
 12h = 12 hours
 1 t = 1 day
 7 t = 7 days
 31 t = 31 days
 1y = 1 year

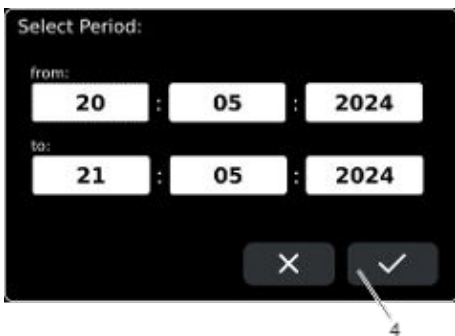

Fig. 135: Period from / to

5. Select the required date/time period using the keyboard that appears, then press the button (4) to confirm.
 - ▶ The temperature profile for the selected period is displayed.

7.9 Variant: Operating the device with CO₂/LN₂ safety cooling

If the cooling system of a LAUDA Versafreeze deep-freezer fails, the cooling temperature of this device variant can be kept constant through the controlled addition of CO₂/LN₂, which will prevent the temperature in the refrigeration compartment from increasing excessively.



DANGER!

Gas displaces atmospheric oxygen or negatively affects oxygen absorption

Danger of asphyxia

- Ventilate rooms adequately.

Personnel: ■ Refrigeration specialist

Protective equipment: ■ Cold protection gloves

■ Safety glasses

1. Read and follow the instructions for "CO₂/LN₂ safety cooling" for installation, starting up, operation and maintenance.

7.10 Variant: Water cooling

! NOTICE!

When decommissioning the device or if there is a risk of freezing:

- Empty the cooling water system using compressed air.
- Empty the cooling water system using an industrial vacuum cleaner suitable for liquids.

Installing a heat exchanger (water-refrigerant) instead of a condenser in the LAUDA Versafreeze deep-freezer significantly reduces the heat discharged from the device into the ambient air, thereby extending the permissible working temperature range.

This process is pressure-controlled by the deep-freezer.

The water cooling variant is not available for models VF 15040 and VF 15085.

An external threaded connection with a union nut for a 1/2" pressure hose is suitable for the connection to a re-cooling system or water supply. For other connections, contact LAUDA Service.

Requirements for water pressure and water temperature:

- Inlet water pressure: 0.2 bar to 10 bar
- Water inlet temperature: 4 °C to 25 °C

Personnel: ■ Specialized personnel

Protective equipment: ■ Protective work clothing

■ Safety glasses

Changing the factory setting is only necessary if the customer's cooling water supply is significantly warmer or colder.

The preset factory value of the cooling water volume controller is printed on the label located on the cover of the cooling water volume controller.

If the cooling water temperature deviates by more than 10 °C, adjust the cooling water volume in small increments (approximately 0.1 on the scale) by turning the cooling water volume controller.

The difference between the cooling water inlet temperature and the cooling water outlet temperature should be between 15 K and 20 K.

1. Remove the cover by loosening the two knurled screws (1).



Fig. 136: Cover



Fig. 137: Cover removed

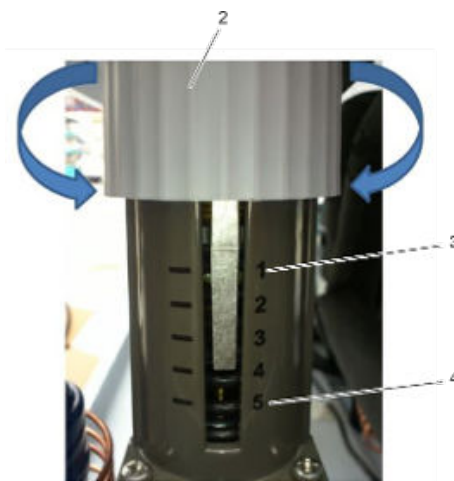

Fig. 138: Adjustment wheel

2. Turning the adjustment wheel (2) toward "1" on the scale (3) increases the cooling water volume, whereas turning the wheel toward "5" on the scale (4) reduces the cooling water volume.
3. Note the new value on the label.
4. Install the cover on the device using the two knurled screws.



Note: In the event of a water shortage, the device switches off automatically. Once a sufficient supply of water has been restored, the device must be switched off completely and then restarted.

8 Maintenance

8.1 General safety instructions



DANGER! Contact with live or moving parts

Electric shock, impacts, cutting, crushing

- Before any maintenance work is performed, the device must be disconnected from the mains power and the mains switch must be set to the [O] position.
- Only skilled certified personnel are permitted to perform repairs.



DANGER! Incorrect handling

Fire

- Only skilled personnel are permitted to perform service and repair work.
- Repair work on the refrigeration system may only be performed by skilled, certified personnel who are trained to handle flammable refrigerants.



WARNING! Uncontrolled leaking of refrigerant

Fire

- Never dispose of a cooling circuit that is still pressurized.
- Disposal tasks may only be performed by skilled, certified personnel who are trained to handle flammable refrigerants.



WARNING! Risk of mechanical damage to refrigerant circuit

Explosion, fire

- Only trained personnel permitted to perform service work.
- Ventilate the room thoroughly without delay.
- During this period, do not operate any switches on the device or anywhere else in the room.
- Do not ignite flames or sparks and refrain from smoking.



CAUTION!
Contact with hot or cold device parts and accessories

Scalding, hot or cold burns

- Allow device parts and accessories to reach room temperature before touching.

8.2 Maintenance plan

Interval	Maintenance task
Daily	Inspect the external condition of the device.
Weekly	Clean the device, see ↪ Chapter 8.3 “Cleaning the device” on page 71.
Monthly	Keep the condenser fins free of dust, see ↪ Chapter 8.4 “Cleaning the condenser fins” on page 72.
As necessary	Defrost the refrigeration compartment, ↪ Chapter 8.5 “Defrosting the refrigeration compartment” on page 73.
	Inspect the device for damage and stability after transport, whenever necessary or annually at the latest.
Annually	Flushing the cooling water system, ↪ Chapter 8.6 “Flushing the cooling water system on the water-cooled variant:” on page 73.

8.3 Cleaning the device



DANGER!
Liquid ingress during cleaning

Electric shock

- Clean with a damp cloth to prevent liquids from entering the electrical components.
- Avoid accumulations of liquid.
- Turn off the mains switch.
- Disconnect the device from the power supply before starting repair or cleaning work.

Personnel: ■ Instructed person

Protective equipment: ■ Protective gloves

Please also note the following:

- Only use water and detergent to clean the Touch control element and other surfaces. Do not use acetone or solvent as these substances will permanently damage the plastic surfaces.
- Ensure that the device is decontaminated after coming into contact with hazardous materials.

- It is forbidden to use decontaminants or cleaning agents that may react with parts of the device or materials contained in those parts and potentially pose a **hazard**.
- We recommend using ethanol as a decontaminant. If you are unsure whether decontaminants or cleaning agents are compatible with device parts or the materials contained in those parts, please contact LAUDA Service.

8.4 Cleaning the condenser fins

In order to ensure that the device operates efficiently, the condenser fins must be cleaned monthly or more often, if necessary, in dirty ambient conditions.



WARNING!
Incorrect handling, refrigerant leaks

Fire, cutting

- The condenser fins have very sharp edges. Therefore, always use protective gloves,
- Use suitable materials for cleaning such as a soft brush, a vacuum cleaner or compressed air.



CAUTION!
Compressors and pressure lines reach temperatures of approximately 75 degrees

Burns

- Switch off the device and disconnect from the main power supply.
- Set the main switch to the [O] position.
- Allow device parts and accessories to reach room temperature before touching them.

- Personnel: ■ Instructed person
- Protective equipment: ■ Safety glasses
 ■ Protective gloves

1. Switch off the device at the mains switch, see ↗ Chapter 6.2 “Switching the device on and off” on page 43.
2. Disconnect the power connection.
3. Clean the fins on the condenser with a brush or use a vacuum cleaner or compressed air to clean the fins. Do not apply pressure to, or damage, the fins.
4. Connect the device to the mains power supply, see ↗ Chapter 6.1 “Establishing a mains connection” on page 41.

8.5 Defrosting the refrigeration compartment

Defrost the refrigeration compartment of the device whenever necessary, or if there is heavy freezing.



WARNING! Refrigerant leaks

Fire, device damage

- Allow the ice in the refrigeration compartment to defrost on its own.
- Do not place heating devices in the refrigeration compartment.
- Do not use sharp objects or chip/scrape off the ice.

Personnel: ■ Instructed person

Protective equipment: ■ Cold protection gloves

1. Switch off the device, see ↗ Chapter 6.2 “Switching the device on and off” on page 43.
2. Disconnect the mains plug from the socket.



NOTICE!

Make sure that liquids cannot enter the cable connections or the electrical components inside the device.

3. Open the refrigeration compartment door.
4. Remove the contents from the refrigeration compartment.
5. Allow the ice to defrost.
6. Continuously remove the melt water from the refrigeration compartment.
7. Allow the refrigeration compartment to dry or wipe dry with a soft cloth.
8. Once the refrigeration compartment is free of ice and dry, reconnect the device to the mains power supply, see ↗ Chapter 6.1 “Establishing a mains connection” on page 41 and ↗ Chapter 6.2 “Switching the device on and off” on page 43

8.6 Flushing the cooling water system on the water-cooled variant:

Depending on the cooling water quality, the water cooling system of the deep-freezer should be flushed at least once a year.

Personnel: ■ Instructed person

Protective equipment: ■ Protective work clothing

■ Protective gloves

■ Safety glasses

The system can be flushed while the device is operating. The device does not have to be emptied or disconnected from the power supply.

In order to ensure an optimal flushing process, the compressor(s) must be active during the flushing process. The rotating symbols on the Touch operating unit indicate that the compressor(s) are active.



Fig. 139: Removing the cover

1. Remove the cover by loosening the two knurled screws (1).
2. Read off and note down the current setting of the cooling water controller.



Fig. 140: Adjustment wheel

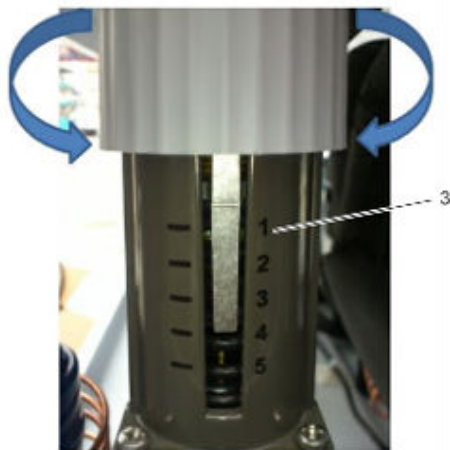

Fig. 141: Scale

3. Move the cooling water volume controller from the current position to position "1" on the scale (3) by turning the adjustment wheel (2).
4. Leave the cooling water volume controller in this position for about three minutes.
5. Then turn the controller back to the original position.
 - ▶ Loose deposits from the deep-freezer water cooling system are reliably removed/flushed out.
6. Install the cover on the device using the two knurled screws.



It is normal for the compressor to ice over slightly during the flushing process, and the ice will disappear once the flushing process is complete.

9 Faults

9.1 Alarms, warnings and errors

Additional display	Error text/fault text	Message with acoustic alarm	Acknowledge acoustic alarm	Description/meaning/comments	Corrective action
ErrL	Short circuit on sensor F1	Yes	Yes	Ohmic measured value of sensor 1 too low	Have sensor replaced by LAUDA Service.
ErrH	Cable break on sensor F1	Yes	Yes	Ohmic measured value of sensor 1 too high	Have sensor replaced by LAUDA Service.
ErrL	Short circuit on sensor F2	Yes	Yes	Ohmic measured value of sensor 2 too low	Have sensor replaced by LAUDA Service.
ErrH	Cable break on sensor F2	Yes	Yes	Ohmic measured value of sensor 2 too high	Have sensor replaced by LAUDA Service.
	Battery unsuitable (data logger battery)	Yes	Yes	Battery is unsuitable/battery values do not comply with the preset default values	Contact LAUDA Service and install the battery recommended by the manufacturer.
	Battery faulty or missing (data logger battery)	Yes	Yes	Battery defective or missing/battery missing according to q44	Contact LAUDA Service and install the battery recommended by the manufacturer.
	Battery voltage low (data logger battery)	Yes	Yes	Battery voltage low/output in battery mode	Check the battery and, if necessary, have the recommended battery replaced by LAUDA Service.
	Door contact	Yes	Yes	Door contact error/door open or closed depending on parameterization b60-b63	Close door/cover.
	Limit value 1, low value	Yes	Yes	Temperature value is lower than A13/freely adjustable monitoring of process variables	Device too cold. The device may not yet be filled with refrigerated goods. Adjust the limit value. Goods stored in the device may be colder than the device's set point temperature. Acknowledge the alarm and wait until the refrigerated goods have reached the device's set point temperature. The second stage compressor may not switch off. Contact LAUDA Service.

Additional display	Error text/fault text	Message with acoustic alarm	Acknowledge acoustic alarm	Description/meaning/comments	Corrective action
	Limit value 1, high value	Yes	Yes	Temperature value is higher than A15/freely adjustable monitoring of process variables	Device too warm. Device may still be in the cooling phase. Wait until the set point is reached. The ambient temperature may be too high. Allow to cool. Condenser may be contaminated. Vacuum off the condenser or blow clean with compressed air (do not blow clean near smoke detectors as the disturbed dust may trigger the fire alarm). The device may be positioned too close to a wall. Ensure that the device is positioned 15 cm away from the wall. Warm exhaust air from another device may be blowing into the device's condenser. The device and motor compartment may be positioned next to a heater or heating pipes. Move the device to another location. The ventilator fan may have failed. Contact LAUDA Service. Have alarms such as the power failure or door contact alarms been previously triggered? Rectify the fault.
	Limit value 2, low value	Yes	Yes	Temperature value is lower than A23/freely adjustable monitoring of process variables	Device is too cold. Operation no longer possible. If possible, operate in another location or increase the room temperature to over 16 °C.
	Limit value 2, high value	Yes	Yes	Temperature value is higher than A25/freely adjustable monitoring of process variables	Ambient temperature too high and/or the condenser is heavily contaminated. Clean the condenser and wait for 10 minutes before commissioning the device. Description: A fault in the condenser causes the compressors to continuously switch on and off against high pressure which may end up destroying the compressors.

Additional display	Error text/fault text	Message with acoustic alarm	Acknowledge acoustic alarm	Description/meaning/comments	Corrective action
	EPO Program error	Yes	Yes	Flash error, repair possible/possibly switch on/off (min. 10 seconds), otherwise see EP2	If necessary, replace the controller board. Contact LAUDA Service.
	EP1 Parameter error	Yes	Yes	Parameter configuration incorrect/correct parameters, otherwise EP2	If necessary, replace the controller board. Contact LAUDA Service.
	EP2 memory error	Yes	Yes	Flash error irreparable/reinstall software	If necessary, replace the controller board. Contact LAUDA Service.
F90	Controller not found	Yes	Yes		Contact LAUDA Service.
F92	Internal communication issue	Yes	Yes	Possible switch on/off (min. 10 sec.)	Contact LAUDA Service.
F93	Memory error in operating unit/controller	Yes	Yes		Contact LAUDA Service.

10 Decommissioning

10.1 General information on decommissioning



NOTICE!

When decommissioning the device or if there is a risk of freezing:

- Empty the cooling water system using compressed air.
- Empty the cooling water system using an industrial vacuum cleaner suitable for liquids.

Information on decommissioning

- Remove refrigerated goods from the refrigeration compartment, see ↪ Chapter 7.3 “Storing and retrieving refrigerated goods” on page 59.
- Download data from the device, see ↪ Chapter 7.5 “Data transfer via USB” on page 61.
- Switch off the device, see ↪ Chapter 6.2 “Switching the device on and off” on page 43.
- Defrost the refrigeration compartment, see ↪ Chapter 8.5 “Defrosting the refrigeration compartment” on page 73.
- Clean the device, see ↪ Chapter 8.3 “Cleaning the device” on page 71.
- Note the storage temperature of the device, see ↪ Chapter 12.3 “Device data” on page 81.

11 Disposal

11.1 Disposing of refrigerant



DANGER!
Incorrect handling

Fire

- Disposal work on the refrigeration system may only be performed by skilled, certified personnel who are trained to handle flammable refrigerants.



WARNING!
Uncontrolled leaking of refrigerant

Fire

- Never dispose of a cooling circuit that is still pressurized.
- Disposal tasks may only be performed by skilled, certified personnel who are trained to handle flammable refrigerants.



Refrigerant type and charge information is printed on the type plate or in the technical data.

11.2 Device disposal



The following applies for EU member states: The device must be disposed of according to Directive 2012/19/EU (WEEE Waste of Electrical and Electronic Equipment).

11.3 Disposing of packaging

The following applies for EU member states: Disposal of the packaging must proceed according to regulation 94/62/EC.

12 Technical data



The device sound pressure level is below 70 dB. According to EC Directive 2006/42/EC the sound pressure level of the devices is therefore not specified further.

12.1 Touch operating unit data

Designation/details	Description/value	Unit
Display type	TFT color display, touch screen	---
Display size	4.3	Inches
Display resolution	480x272	Pixels

12.2 Auxiliary battery data

Designation/details	Value/designation	Unit
Manufacturer	Long	---

12.3 Device data

Designation/details		Value/designation	Unit
External dimensions (WxDxH)	VF 15040	904x776x865	mm
	VF 15085		
	VF 60040	980x1029x1965	mm
	VF 60085		
	VF 70040	980x1179x1965	mm
	VF 70085		
Internal dimensions of refrigeration compartment (WxDxH)	VF 15040	480x480x560	mm
	VF 15085		
	VF 60040	738x600x1320	mm
	VF 60085		
	VF 70040	738x750x1320	mm
	VF 70085		
Refrigeration compartment volume	VF 15040	129	Liters
	VF 15085		
	VF 60040	584	Liters
	VF 60085		
	VF 70040	730	Liters
	VF 70085		

Designation/details		Value/designation	Unit
Empty weight	VF 15040	145	kg
	VF 15085	165	kg
	VF 60040	325	kg
	VF 60085	350	kg
	VF 70040	350	kg
	VF 70085	375	kg
Maximum load capacity per intermediate shelf, with even load distribution	VF 60085	Standard 40	kg
	VF 70085		
Maximum load capacity per drawer (optional), with even load distribution	VF 15085	12	kg
	VF 60085	15	kg
	VF 70085	15	kg
Floor load-bearing capacity required at the installation location	VF 15040	70	N/cm ²
	VF 15085	80	N/cm ²
	VF 60040	159	N/cm ²
	VF 60085	179	N/cm ²
	VF 70040	170	N/cm ²
	VF 70085	190	N/cm ²
Temperature control		Single-board controller	
Temperature range	VF 15040	0 to -40	°C
	VF 60040		
	VF 70040		
	VF 15085	-50 to -86	°C
	VF 60085		
	VF 70085		
Temperature stability (over time)	VF 15040	+/-1.5 at -40	°C
	VF 60040		
	VF 70040		
	VF 15085	+/-1.5 at -86	°C
	VF 60085		
	VF 70085		
Temperature setting and temperature display		Touch display	
Electrical connection		230 / 50, +/-10 %	V / Hz
Main fuse on site		16	A
Electrical connection		220 / 60, +/-10 %	V / Hz

Designation/details		Value/designation	Unit
Main fuse on site		16	A
Electrical connection		115 / 60, +/-10 %	V / Hz
Main fuse on site		16	A
Main fuse on site for models	VF 60085	30	A
	VF 70085		
Power consumption at 230 V / 50 Hz	VF 15040	0.5	kW
	VF 60040	1.2	
	VF 70040		
	VF 15085	1.0	kW
	VF 60085	2.0	
VF 70085			
Power consumption at 220 V / 60 Hz	VF 15040	0.4	kW
	VF 15085	0.8	
Power consumption at 115 V / 60 Hz	VF 15040	0.6	kW
	VF 60040	1.3	
	VF 70040		
	VF 15085	1.2	kW
	VF 60085	2.2	
VF 70085			
Power supply connector type		Safety plug ¹	---
Mains voltage deviation		+/- 10	%
Overvoltage category		II	---
Pollution degree		2	---
Protection level/protection class		IP 20	---
Maximum geographical altitude above sea level		2000	m
Maximum relative humidity		75 % at 28 °C, no condensation	---
Ambient conditions		Only inside buildings Not in hazardous areas	
Ambient temperature		16 to 28	°C
Storage temperature (decommissioned device)		5 to 43	°C

¹ Connection value 230 V/50 Hz, Switzerland: Adapter fixed connection T23 SEV 5934/2 (16A)

¹ Connection value 230 V/50 Hz, UK: Adapter GB 13A, BS 1363

12.4 Refrigerant and filling charge

The device contains flammable refrigerants.

Table 2: Refrigerant filling, first stage, air cooling

	VF 15040	Unit
Refrigerant	R 1270	---
Maximum filling weight	0.135	kg

	VF 60040 VF 70040	Unit
Refrigerant	R 1270	---
Maximum filling weight	0.145	kg

	VF 15085	Unit
Refrigerant	R 290	---
Maximum filling weight	0.135	kg

	VF 60085 VF 70085	Unit
Refrigerant	R 290	---
Maximum filling weight	0.145	kg

Table 3: Refrigerant filling, first stage, water cooling

	VF 60040 VF 70040	Unit
Refrigerant	R 1270	---
Maximum filling weight	0.145	kg

	VF60085 VF 70085	Unit
Refrigerant	R 290	---
Maximum filling weight	0.135	kg

Table 4: Refrigerant filling, second stage

	VF 15085	Unit
Refrigerant	R 170	---
Maximum filling weight	0.050	kg

	VF 60085	Unit
Refrigerant	R 170	---
Maximum filling weight	0.090	kg

	VF 70085	Unit
Refrigerant	R 170	---
Maximum filling weight	0.096	kg

12.5 Circuit diagram

12.5.1 Legend for the following circuit diagrams

A1	Single-board refrigeration controller
A2	Touch operating unit
F3	Over pressure switch, first stage
F4	Over pressure switch, second stage
F5	Microfuse 1.6 AT
F6	Microfuse 1.6 AT
S1	Mains switch
K1	Main contactor
K2	Potential-free contact
M1	Compressor, first stage
M2	Compressor, second stage
M3	Fan motor 1,000 rpm or 1,500 rpm

12.5.2 Circuit diagram: VF 15040, 115V/60Hz

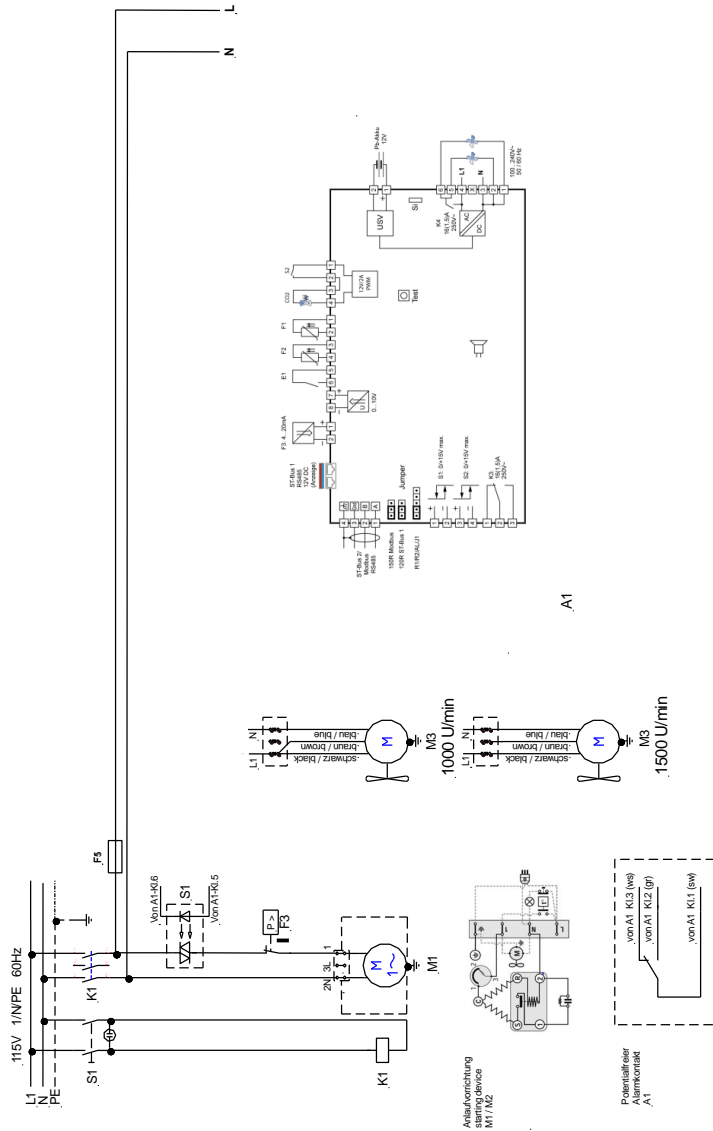

Fig. 142: Schaltplan_Tiefkühlschrank_VF15040_115V_60Hz

12.5.3 Circuit diagram: VF 15040, 230V/50Hz

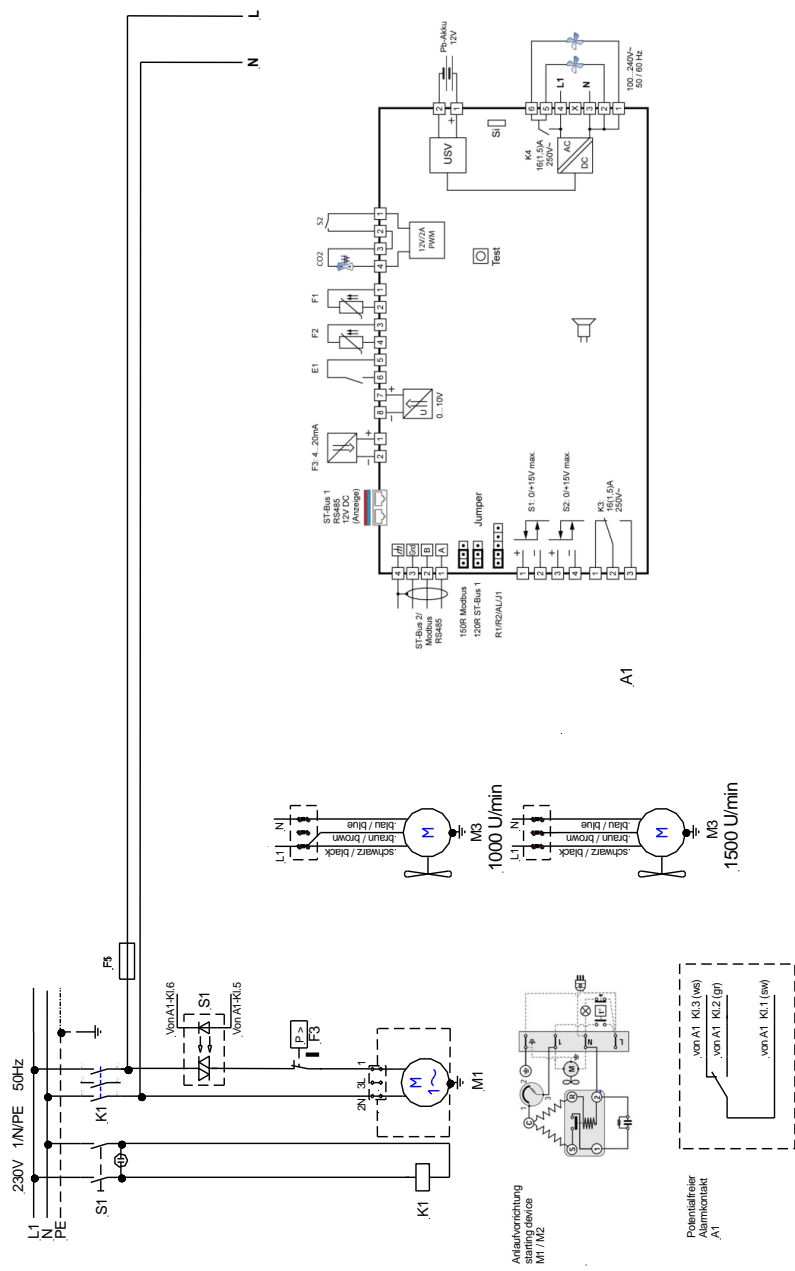

Fig. 143: Schaltplan_Tiefkühlschrank_VF15040_230V_50Hz

12.5.4 Circuit diagram: VF 15085, 115V/60Hz

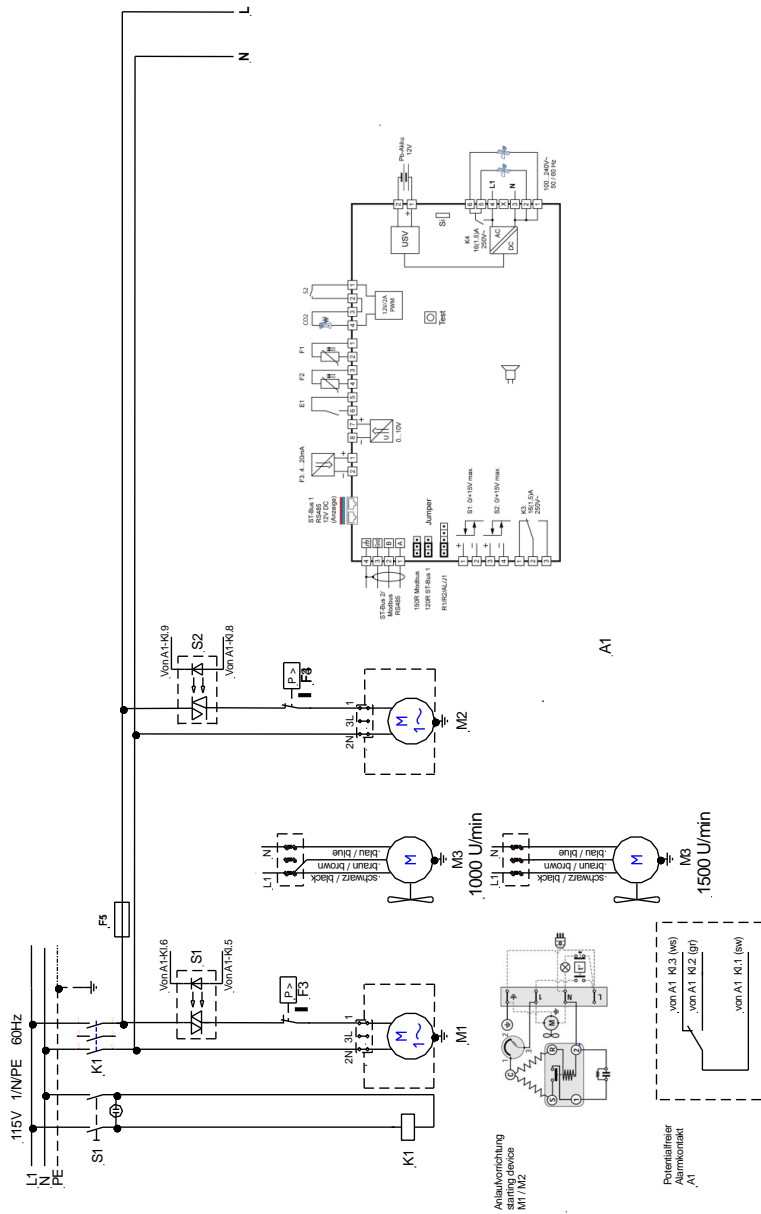

Fig. 144: Schaltplan_Tiefkühlschrank_VF15085_115V_60Hz

12.5.5 Circuit diagram: VF 15085, 230V/50Hz

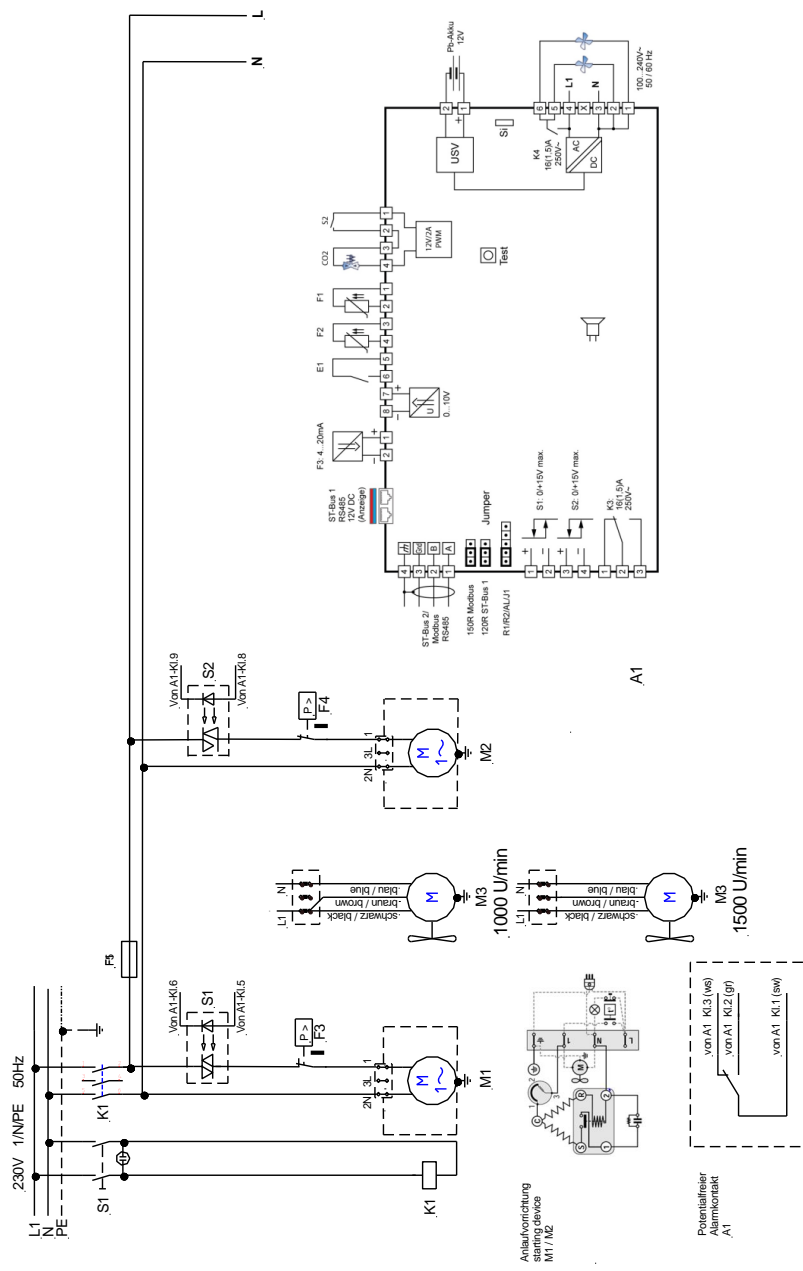

Fig. 145: Schaltplan_Tiefkühlschrank_VF15085_230V_50Hz

12.5.6 Circuit diagram: VF 60040 and VF 70040, 115V/60Hz

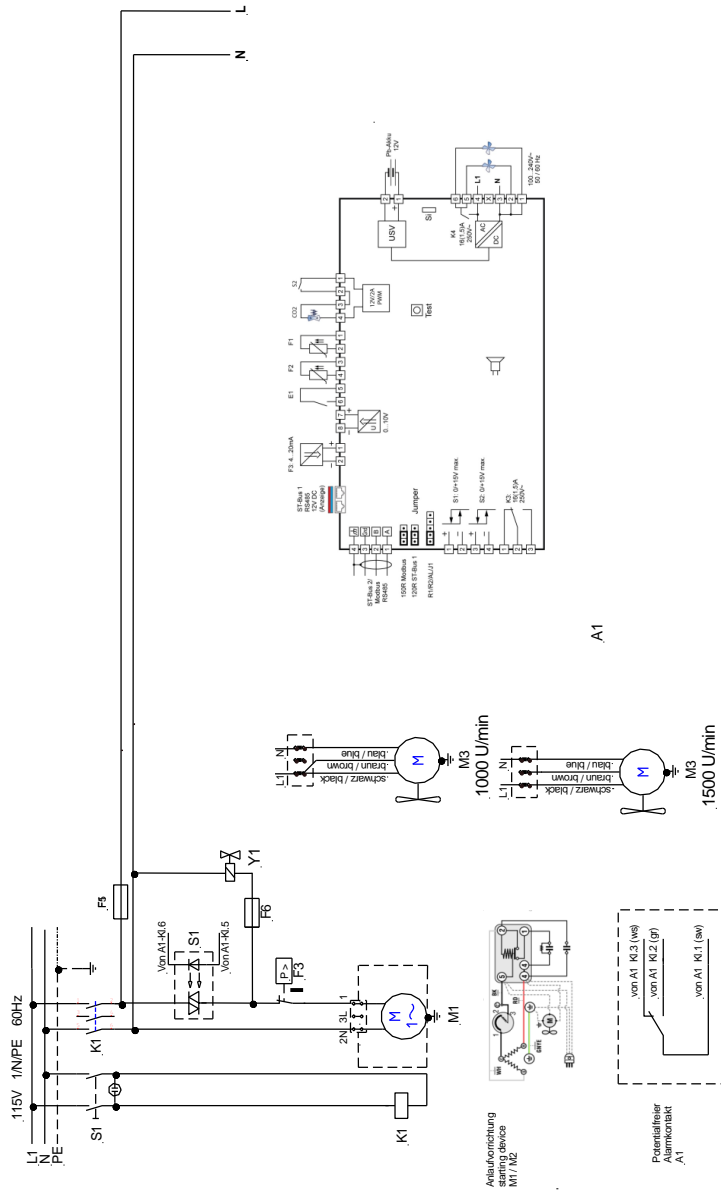

Fig. 146: Schaltplan_Tiefkühlschrank_VF60040_VF70040_115V_60Hz

12.5.7 Circuit diagram: VF 60040 and VF 70040, 230V/50Hz

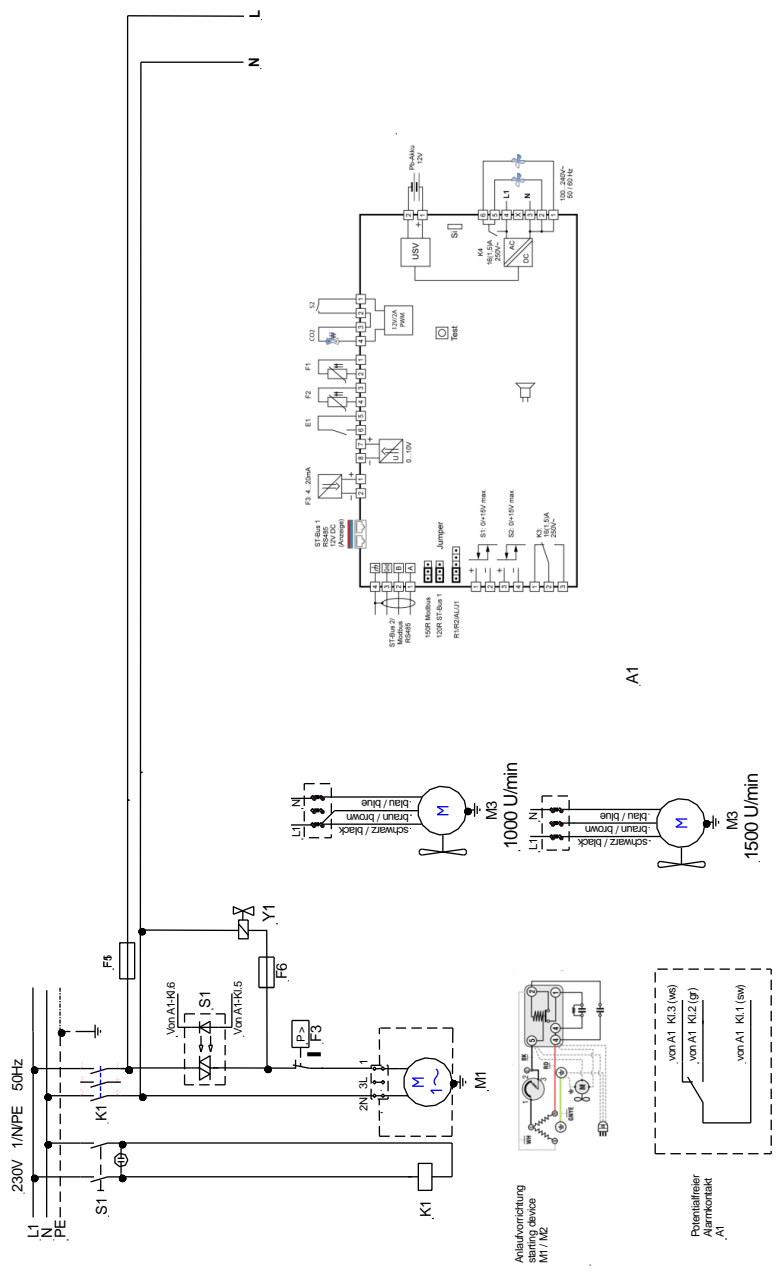

Fig. 147: Schaltplan_Tiefkühlschrank_VF60040_VF70040_230V_50Hz

12.5.8 Circuit diagram: VF 60085 and VF 70085, 115V/60Hz

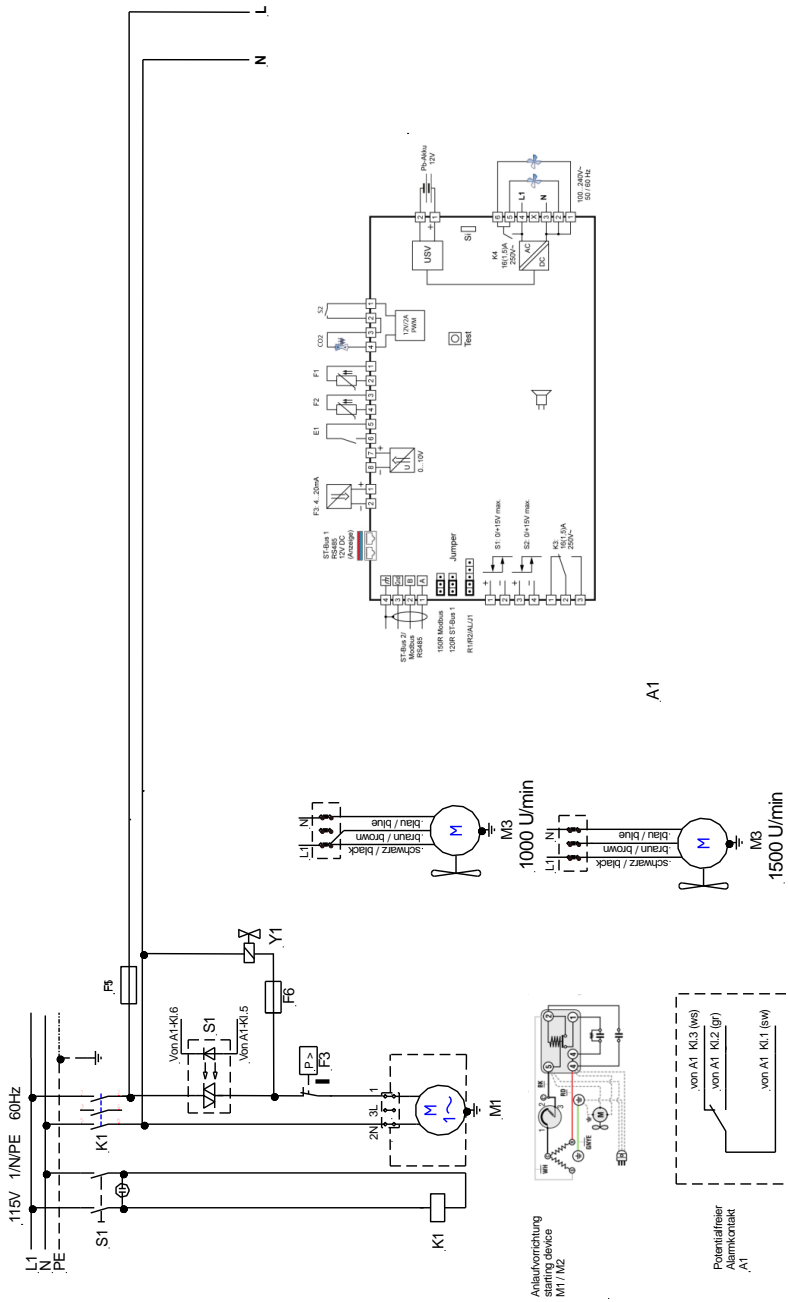

Fig. 148: Schaltplan_Tiefkühlschrank_VF60085_VF70085_115V_60Hz

12.5.9 Circuit diagram: VF 60085 and VF 70085, 230V/50Hz

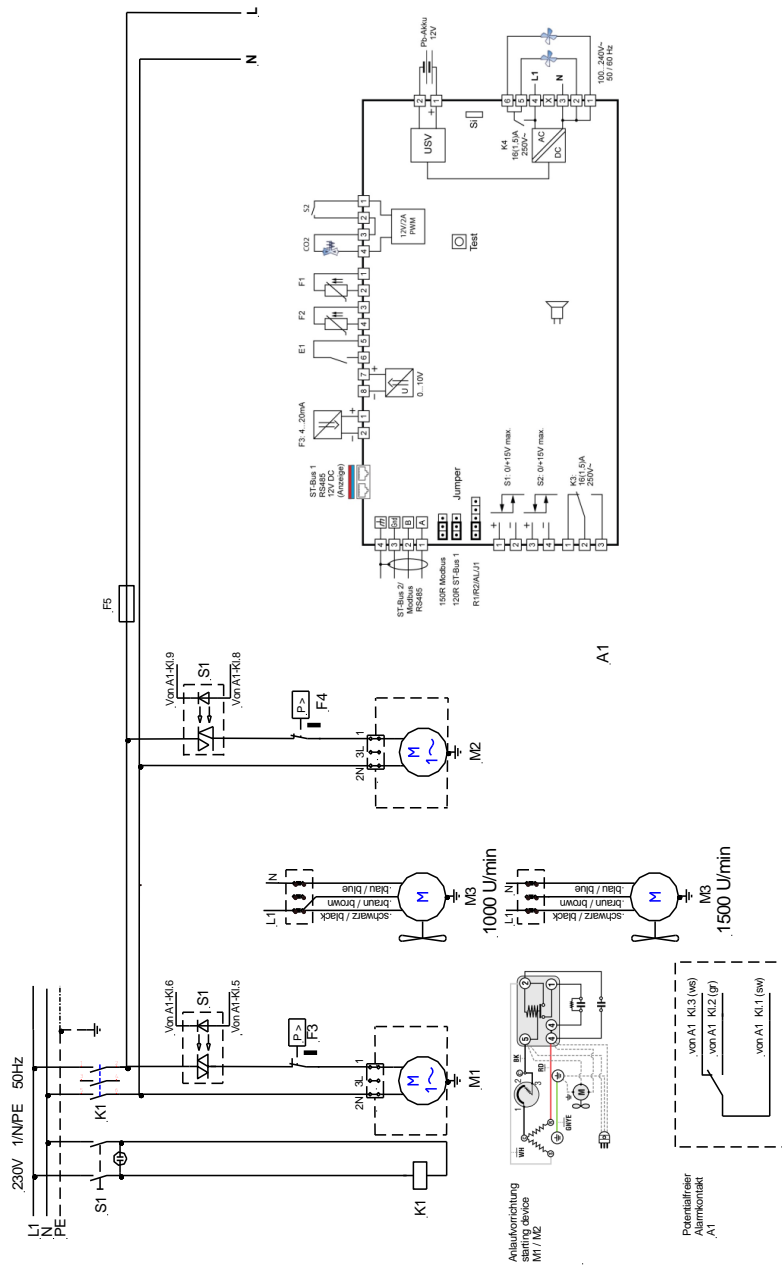

Fig. 149: Schaltplan_Tiefkühlschrank_VF60085_VF70085_230V_50Hz

12.5.10 Touch operating unit

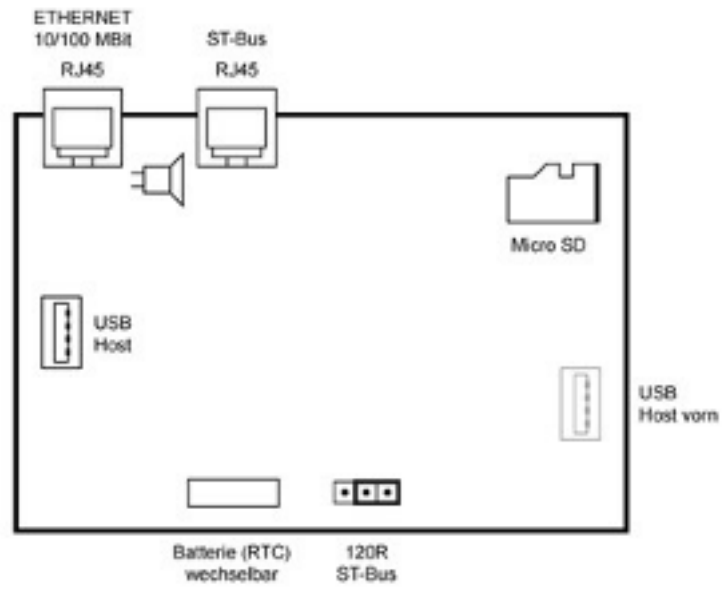

Fig. 150: Touch operating unit

12.5.11 Single-board refrigeration controller A1

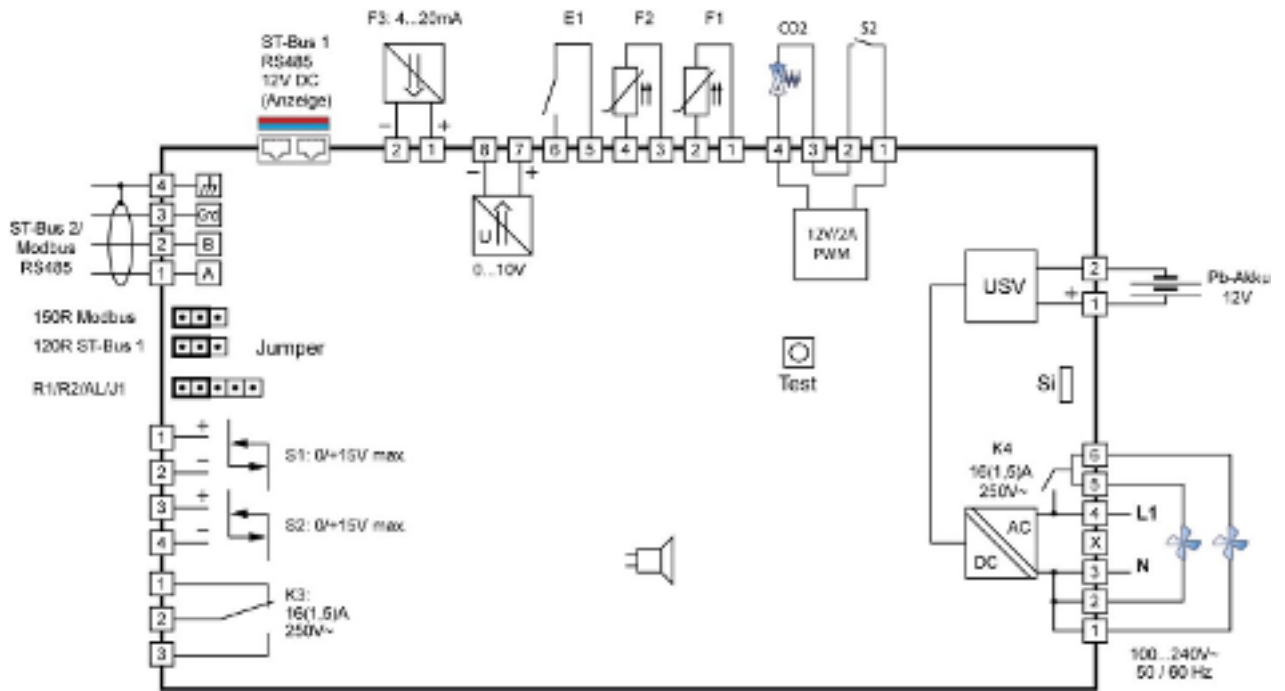

Fig. 151: Single-board refrigeration controller

F1	Temperature probe PT100, refrigeration compartment
F2	Temperature probe PT100, condenser
E1	Door switch/lid switch
S2	CO ₂ /LN ₂ switch
S1	Solid state relay, first stage, 0/+15V max.
S2	Solid state relay, second stage, 0/+15V max.
K3	Potential-free contact

13 Auxiliary devices

13.1 Auxiliary devices for data loggers and storage systems

13.1.1 Data logger for monitoring and recording the temperature in the refrigeration compartment

The data logger is used for external monitoring and recording of temperatures in the refrigeration compartment.

It is fitted with a PT1000 temperature probe with a 3-m-long PTFE insulated cable, which enters the refrigeration compartment via the device's duct or a separate optional duct.

The data logger has an adjustable limit value monitor with an acoustic alarm, and has sufficient memory for up to 60,000 measured values with recording intervals ranging from 1 second to 24 hours (adjustable).

Data can be exported directly to a PC via the supplied USB cable. A Windows software program (German, English, French) for configuring the data logger is included in the delivery.

Order number:	Description
A001383	Data logger with PT1000 temperature probe, bracket, software for configuring the data logger and USB cable for transferring data to a PC.

13.1.1.1 Accessories for data logger A001383

Order number:	Description
A001384	Temperature brake aluminum block for attaching the temperature probe in the refrigeration compartment. It delays the response time of the probe in the event of temperature changes.
A000147	Calibration of data logger A001383 at a specific customer temperature value; with certificate.

13.1.2 Storage system

13.1.2.1 Plug-in units with drawers

Device type	Refrigeration compartment volume in liters	Content	Order no. for 1 box	Number of plug-in units per device	Order no. for 1 plug-in unit	Number of boxes/plates per plug-in unit	Number of boxes/plates per device
VF 15040 VF 15085	129	Box 50 mm	A001386	9	A001407	9	81
		Box 75 mm	A001387	9	A001408	6	54
		Box 130 mm	A001388	9	A001409	3	27
		Microtiter plates		6	A001416	35	210
VF 60040 VF 60085	584	Box 50 mm	A001386	35	A001410	12	420
		Box 75 mm	A001387	35	A001411	8	280
		Box 130 mm	A001388	35	A001412	4	140
		Microtiter plates		35	A001417	42	1470
VF 70040 VF 70085	731	Box 50 mm	A001386	35	A001413	15	525
		Box 75 mm	A001387	35	A001414	10	350
		Box 130 mm	A001388	35	A001415	5	175
		Microtiter plates		35	A001418	56	1960

13.1.2.2 Plug-in units with side loading

Device type	Refrigeration compartment volume in liters	Content	Order no. for 1 box	Number of plug-in units per device	Order no. for 1 plug-in unit	Number of boxes/plates per plug-in unit	Number of boxes/plates per device
VF 15040 VF 15085	129	Not available for these device models.					
VF 60040 VF 60085	584	Box 50 mm	A001386	35	A001401	12	420
		Box 75 mm	A001387	35	A001402	8	280
		Box 130 mm	A001388	35	A001403	4	140
		DeepWell plates/ test plates		35	A001419	18/54	630/1890
VF 70040 VF 70085	731	Box 50 mm	A001386	35	A001404	15	525
		Box 75 mm	A001387	35	A001405	10	350
		Box 130 mm	A001388	35	A001406	5	175
		DeepWell plates/ test plates		35	A001420	24/72	840/2520

13.1.2.3 Boxes

Description		Order no.
Cryo box, 136x136x50 mm, cardboard	white, water-repellent	A001386
Cryo box, 136x136x75 mm, cardboard	white, water-repellent	A001387
Cryo box, 136x136x130 mm, cardboard	white, water-repellent	A001388

13.1.2.4 Grid

Description		Order no.
Grid divider for 100 tubes Ø12.5 mm, 25 mm high	for boxes 136x136 mm	A001389
Grid divider for 64 tubes Ø15.0 mm, 25 mm high	for boxes 136x136 mm	A001390
Grid divider for 49 tubes Ø17.0 mm, 40 mm high	for boxes 136x136 mm	A001391
Grid divider for 16 tubes Ø31.0 mm, 65 mm high	for boxes 136x136 mm	A001392

14 General

14.1 Copyright

This manual is protected by copyright and only meant for internal use by purchasers.

The relinquishment of this manual to third parties, copying in any way whatsoever – even in the form of excerpts – and the utilization and/or conveyance of its content are not allowed, except for internal purposes, without written approval from the manufacturer.

Violation of this may obligate the violator to the payment of damages. Other claims reserved.

We point out that the designations and brand names of the respective companies used in the manual are generally subject to trademark, brand and patent protection.

14.2 Technical changes

The manufacturer reserves the right to make technical modifications to the device.

14.3 Warranty conditions

LAUDA guarantees a standard 12-month manufacturer's warranty from the date of the device's purchase.

14.4 Contact LAUDA

Contact LAUDA Service in the following cases:

- Troubleshooting
- Technical questions
- Ordering accessories and spare parts

Please contact our sales department for questions relating to your specific application.

Contact information

LAUDA Service

Phone: +49 (0)9343 503-350

Email: service@lauda.de

14.6 Certificate

The certificate is only valid for devices with cTÜV us certification marks on the type plate.

ZERTIFIKAT ♦ CERTIFICATE ♦ 証明書 ♦ CERTIFICADO ♦ CERTIFICAT





CERTIFICATE

No. U8 019054 0013 Rev. 00

Holder of Certificate: LAUDA DR. R. WOBSEY GMBH & CO. KG
Lauda Platz 1
 67922 Lauda-Köningshofen
 GERMANY

Certification Mark:



Product: Laboratory Equipment
(Chest freezer)

This product was voluntarily tested to the relevant safety requirements referenced on this certificate. It can be marked with the certification mark above. The mark must not be altered in any way. This product certification system operated by TÜV SÜD America Inc. most closely resembles system 3 as defined in ISO/IEC 17067. Certification is based on the TÜV SÜD "Testing and Certification Regulations". TÜV SÜD America Inc. is an OSHA recognized NRTL for USA and a Standards Council of Canada ISO/IEC 17065 accredited Certification body for Canada.

Test report no.: 713213423-00

Date: 2023-02-15

Siemon
(Thorsten Siemon)

Page 1 of 2
 TÜV SÜD America, Inc. • 401 Edgewater Place Suite #500 • Weymouth • MA 01980 • USA





CERTIFICATE

No. U8 019054 0013 Rev. 00

Model(s):
 VF20040C
 VF20085C
 VF55040C
 VF55085C
 VF75040C
 VF75085C

Tested according to:
 UL 61010-1:2012/R:2019-07
 CSA C22.2 No. 61010-1:2012/A1:2018-11
 CSA C22.2 No. 61010-2-011:2019

Also evaluated to the following standards:
 UL 61010-2-011:2021

Parameters:

VF20040C	230 V / 50 Hz 115 V / 60 Hz	0.6 kW 0.7 kW
VF20085C	230 V / 50 Hz 115 V / 60 Hz	1.2 kW 1.3 kW
VF55040C	230 V / 50 Hz 115 V / 60 Hz	1.2 kW 1.3 kW
VF55085C	230 V / 50 Hz 115 V / 60 Hz	2.0 kW 2.2 kW
VF75040C	230 V / 50 Hz 115 V / 60 Hz	1.2 kW 1.3 kW
VF75085C	230 V / 50 Hz 115 V / 60 Hz	2.0 kW 2.3 kW

Fig. 153: Certificate

14.7 Product Returns and Clearance Declaration

Product Returns

Would you like to return a LAUDA product you have purchased to LAUDA? For the return of goods, e.g. for repair or due to a complaint, you will need the approval of LAUDA in the form of a *Return Material Authorization (RMA)* or *processing number*. You can obtain the RMA number from our customer service department at +49 (0) 9343 503 350 or by email service@lauda.de.

Return address

LAUDA DR. R. WOBSE GMBH & CO. KG

Laudaplatz 1

97922 Lauda-Königshofen

Deutschland/Germany

Clearly label your shipment with the RMA number. Please also enclose this fully completed declaration.

RMA number	Product serial number
Customer/operator	Contact name
Contact email	Contact telephone
Zip code	Place
Street & house number	
Additional explanations	

Clearance Declaration

The customer/operator hereby confirms that the product returned under the above-mentioned RMA number has been carefully emptied and cleaned, that any connections have been sealed to the farthest possible extent, and that there are no explosive, flammable, environmentally hazardous, biohazardous, toxic, radioactive or other hazardous substances in or on the product.

Place, date	Name in block letters	Signature

15 Index

A		
Ambient conditions	9	
Auxiliary devices	96	
C		
Certificate	101	
Circuit diagram	85	
Cleaning	71	
Condenser fins		
Cleaning the condenser fins	72	
Contact	99	
Cooling water system	73	
Copyright	99	
D		
Data logger	96	
Declaration of Conformity	100	
Defrosting	73	
Device	43	
Cleaning	71	
Decontamination	71	
Disposal (packaging)	80	
Disposal (refrigerant)	80	
Installation	33	
Unpacking	15	
Disposal		
Packaging	80	
Refrigerant	80	
Disposing of refrigerant	80	
E		
Emissions class	8	
Establishing a mains connection	41	
Establishing a power supply	41	
F		
Faults	76	
Flushing	73	
I		
Immunity	8	
Industrial truck	18	
Installation (device)	33	
Installation location	33	
L		
Low temperature alarm	13	
M		
Mains switch		
Operation	29	
O		
Operating conditions	9	
Overtemperature alarm	13	
P		
Packaging		
Disposal	80	
Personal protective equipment (overview)	11	
Personnel qualifications (overview)	10	
Protective equipment (personal, overview)	11	
R		
Refrigerant		
Flammable	10	
Refrigeration compartment	73	
S		
Safety notice		
General	7	
Service	99	
Storage systems	96	
Switching off	43	
Switching on	43	
T		
Transport	18	
Type plate	30	
U		
Unpacking	15	

W

Warranty 99
Water cooling 73

Manufacturer:

LAUDA DR. R. WOBSE GMBH & CO. KG ° Schulze-Delitzsch-Straße 4+5 ° 30938 Burgwedel

Telephone: +49 (0)5139 9958-0

E-mail: info@lauda.de ° Internet: <https://www.lauda.de>